



RAVELLI



HYDRO

.....

**Handheld Touch
Radio Hydro**

USE AND MAINTENANCE MANUAL



Sommario	
<i>Preface</i>	5
WARRANTY	6
<i>Certificate of warranty</i>	6
<i>Warranty conditions</i>	6
<i>Registration of warranty</i>	6
<i>Info and problems</i>	6
GENERAL INFORMATION	7
<i>Supply and safe-keeping</i>	7
<i>Language</i>	7
<i>Symbols used in the manual</i>	7
SAFETY MEASURES	7
<i>General safety warnings</i>	7
<i>Residual risks</i>	8
DESCRIPTION OF THE STOVE	9
<i>Intended use</i>	9
<i>Reasonably foreseeable incorrect use</i>	9
<i>Obligations and forbidden actions</i>	10
<i>Characteristics of the fuel</i>	11
<i>Non-permitted fuels</i>	11
<i>Automatic cleaning system</i>	20
<i>Recharge the fuel</i>	20
<i>Doors opening</i>	20
<i>User training</i>	20
<i>Safety devices</i>	21
SHIPPING AND INSTALLATION	22
<i>Safety warnings for transportation and installation</i>	22
<i>Set-ups for the smoke evacuation system</i>	23
<i>Installation</i>	24
CONNECTIONS	27
<i>Chimney connection</i>	27
<i>Components</i>	27
<i>Stove-system connection</i>	27
<i>Connection of external probe or thermostat</i>	28
<i>Testing and commissioning</i>	28
<i>Electric scheme</i>	29
<i>Connections for hydraulic diagrams</i>	30
PLUMBING SYSTEM CONNECTIONS	32
<i>Installation advice</i>	32
<i>Hydraulic diagrams</i>	33
<i>System water characteristics</i>	36
<i>System water load</i>	36
CONTROLS AND USE	37
<i>Control panel description</i>	37
<i>Handheld touch radio initialization</i>	37
<i>Description of the handheld set</i>	38
PROCEDURES FOR USE	39
<i>Checks prior to start-up</i>	39
<i>Feed screw loading</i>	39
<i>Failed ignition</i>	39
<i>Description of the display and temperature adjustment</i>	40
<i>Quick status display</i>	41

OPERATING PHASES OF THE APPLIANCE	42
<i>Sequence of ignition phases</i>	42
<i>Eco stop</i>	42
<i>Stand-by</i>	42
<i>Sanitary</i>	42
<i>Description of menu functions</i>	42
<i>Setting</i>	46
<i>Anti-condensation system</i>	47
<i>Stove phase general layout</i>	48
MAINTENANCE	53
<i>Safety warnings for maintenance</i>	53
<i>Cleaning</i>	53
<i>Extraordinary maintenance</i>	54
<i>Failure cases</i>	55
STORAGE AND DISPOSAL	58
<i>Disposal</i>	58
TROUBLESHOOTING	58
<i>The stove does not work</i>	58
<i>Difficult lighting</i>	58
<i>Smoke leakage</i>	58
<i>The glass gets dirty easily</i>	58
<i>Downtime (end of season)</i>	58

Preface

Dear Customer, We would like to thank you for choosing one of our stoves.

We invite you to read this manual carefully, before starting installation and use, so that you are able to benefit from all of its characteristics better and in full safety. It contains all necessary information for correct installation, start-up, operation, cleaning, maintenance, etc.

Keep this manual in a suitable location, do not discard it without reading it.

Incorrect installation, maintenance and improper use of the product relieve the Manufacturer of all liability deriving from use of the stove.

For further information and requirements contact your Ravelli-authorized Technical Assistance Centre.

All rights reserved. No part of this instructions manual can be reproduced or transmitted through any electronic or mechanical means, including photocopies, recordings or any other storage system, for other purposes that are not exclusively use by the buyer's staff, without the express written consent of the Manufacturer.

WARRANTY

Certificate of warranty

Ravelli thanks you for the trust granted with the purchase of one of its products and invites the purchaser to:

- read the installation, use and maintenance instructions for the product;
- read the warranty conditions contained below.

Warranty conditions

The warranty for the Customer is acknowledged by the Dealer under the terms of law.

The Dealer acknowledges the warranty only if the product has not been tampered with and only if it has been installed in accordance with the Manufacturer's instructions.

The limited warranty covers manufacturing material defects, as long as the product has not broken due to an incorrect use, negligence, incorrect connection, tampering, installation errors.

The warranty becomes null and void even if only one requirement in this manual is not complied with.

The following are not covered by warranty:

- the combustion chamber refractory stones;
- the door glass;
- the gaskets;
- the paint job;
- the stainless steel or cast iron combustion grille;
- the resistance;
- the Majolica cladding;
- the aesthetic parts;
- any damages caused by unsuitable installation and/or use of the product and/or shortcomings on the part of the customer.

The use of poor quality pellet or any other unauthorised fuel may damage the product's components, cause its warranty to be voided and as a result eliminate the connected manufacturer liability.

It is therefore recommended to use good quality pellet that fulfils the requirements listed in the dedicated chapter.

All damages caused by transportation are not recognised, for this reason it is recommended to carefully check goods upon receipt, immediately warning the reseller of any damage.

Registration of warranty



To activate the warranty, it is necessary to register the product on the Guarantee Portal on the website www.ravelligroup.it, by entering your data and the purchase receipt.

Info and problems

Dealers authorised by Ravelli use a trained Technical Service Centre network to meet the Customer's requirements. For any information or request for assistance, please contact your Dealer or the Technical Service Centre.

GENERAL INFORMATION

Supply and safe-keeping

The manual is supplied in printed format.

Keep this manual safe, with the stove, so that the user can consult it easily.

The manual is an integral part, for safety reasons, therefore:

- **it must be kept intact** (in full). If it gets lost or ruined it is necessary to immediately ask for a new copy:
- **it must be kept with the stove until demolition** (including relocation, sale, rental, lease, etc....).

The Manufacturer will not be held liable for improper use of the stove and/or damage caused by operations that are not set forth in the technical documentation.



Language

The original manual was written in Italian.

Any translations into additional languages must be carried out based on the original instructions.

The Manufacturer is liable for the information contained in the original instructions; the translations into different languages cannot be fully verified therefore if any inconsistency arises it will be necessary to follow the text in the original language or contact our Technical Documentation Office.

Symbols used in the manual

symbol	definition
	This symbol is used to identify particularly important information in the manual. This information also concerns the safety of users involved in using the stove.
	This symbol is used to identify important warnings for the safety of the user and/or the stove.

SAFETY MEASURES

General safety warnings









 Read this instructions manual carefully before stove installation and use. Failure to observe the instructions set forth herein can void the warranty and/or cause damage to property and/or people.

 Stove installation, system verification, operation verification and initial calibration must be carried out exclusively by qualified and authorised staff.

 The stove needs to be connected to a single chimney that guarantees the draught declared by the Manufacturer and observes the installation regulations that apply to the installation site.

 The room where the stove is installed must have an air intake.

 The stove must not be used as an incinerator or differently from its purpose

-  Do not use any fuel other than fire pellet. It is strictly forbidden to use liquid fuels.
-  It is prohibited to use the stove with the door or ash drawer open or the glass broken.
-  Do not touch the hot surfaces of the stove without suitable protective equipment, to avoid getting burned. When it is running, the outer surfaces reach hot temperatures to the touch.
-  It is forbidden to make unauthorised changes to the stove.
-  Before using the stove it is necessary to know the position and function of the controls.
-  If the chimney catches fire you must call the fire brigade.
-  Only use original spare parts. Any tampering and/or replacements that have not been authorised by Ravelli can pose a danger to the user's safety.
-  In the event of particularly adverse weather conditions, the safety systems could intervene and switch off the stove. In any case, do not disable the safety systems.

Residual risks

The stove was designed so as to guarantee the user's essential safety requirements.

Safety was integrated into the stove's design and construction as much as possible.

For every residual risk there is a description of the risk and the zone or part that it applies to (unless the risk applies to the entire stove overall). Procedure-related information is also provided on how to avoid the risk and on the correct use of the personal protective equipment required by and made compulsory by the Manufacturer.

residual risk	description procedure-related information
Risk of burns 	When the stove is running, it may reach high temperatures to the touch, especially on its external surfaces. Take care to avoid burns and use the specific tools if necessary. Use the supplied glove to open pellet cover for loading operations.

DESCRIPTION OF THE STOVE

Intended use

The appliance in question is intended for:

operation	allowed fuel	forbidden	setting
Domestic space heating by burning:	pellet	Any fuel other than the permitted ones.	Residential or Commercial

The stove is designed and built to work safely if:

- it is installed by qualified staff according to the specific standards;
- it is used within the limits declared in the contract and herein;
- the operating manual procedures are followed;
- routine maintenance is carried out according to the times and methods set forth;
- extraordinary maintenance is promptly carried out when needed;
- safety devices are not removed and/or bypassed.

 This stove must be intended for the use it was specifically designed for.

Reasonably foreseeable incorrect use

Reasonably foreseeable incorrect use is listed below:

- using the stove as an incinerator;
- using the stove with fuel other than pellet;
- using the stove with liquid fuels;
- using the stove with the door open and the ash drawer out.

Any use of the appliance other than intended must be preventively authorised in writing by the Manufacturer. Without said written authorisation, the use is considered “improper”. Any contractual and non-contractual liability of the manufacturer is excluded for damages to persons, animals or property due to installation and maintenance adjustment errors and improper use.

Obligations and forbidden actions

Obligations

The user must:

- read this instructions manual before performing any operation on the stove;
- the appliance must not be used by children under the age of 8 or by people with reduced physical, sensorial or mental capacities or without experience or without the necessary knowledge, and always with supervision;
- do not use the stove improperly, i.e. for uses other than those described in the “INTENDED USE” paragraph;
- it is strictly forbidden to use liquid fuels;
- keep objects that are not heat and/or flame-resistant at a safe distance;
- only and exclusively load the stove with pellet with the characteristics described herein;
- connect the stove to a regulation chimney;
- provide a suitable system for the supply of combustion air (air intake or intake duct for watertight stoves);
- always perform maintenance with the stove off and cold;
- perform cleaning activities at the frequency stated herein;
- use original parts recommended by the Manufacturer.

Forbidden actions

The user must never:

- remove or change the safety devices without authorisation;
 - perform operations or manoeuvres of his/her own initiative that are not part of his/her job description, meaning that he/she might jeopardise his/her own safety and that of others;
 - use fuels other than pellet and those allowed for lighting;
 - use the stove as an incinerator;
 - use flammable or explosive substances near the stove during operation;
 - use the stove with the door open and/or with the glass ruined or broken;
 - close the combustion air and smoke outlet openings, whatsoever;
 - use the stove to dry laundry;
 - replace or change some of the stove parts.
-

Characteristics of the fuel

Wood pellet is a fuel made of pressed wood sawdust, often recovered from processing scraps of carpentries. The material used cannot contain any extraneous substance such as, for example, glue, lacquer or synthetic substances.

The sawdust, once it has been dried and cleaned from impurities, is pressed using a die with holes: as a result of high pressure, the sawdust heats up by activating the natural wood binders; this way the pellet maintains its shape even without adding artificial substances.

Wood pellet density varies based on the type of wood and can exceed that of natural wood by 1.5 - 2 times.

The cylinders have a diameter of 6 mm and a variable length between 10 and 40 mm.

Their density is equal to approximately 650 kg/m³. Due to their low water content (< 10%) they have a high energy content.

The UNI EN ISO 17225-2:2014 standard (that replaces the EN PLUS standard) defines pellet quality by specifying three classes: A1, A2 and B. Maintain fuels and other flammables at a suitable distance.

Ravelli recommends using wood pellet classified A1 and A2 according to the EN ISO 17225-2:2014 standard, or certified DIN PLUS (more restrictive than the A1 class) or ONORM M 7135. Pellet may be light or dark coloured, it is normally bagged into bags that show the name of the producer, the main characteristics and classification according to standards.



Pellets must be transported and stored in a dry area. Upon contact with humidity they swell and become unusable



It is therefore necessary to protect them from humidity, both during transport and during storage.

Non-permitted fuels

We recommend not using the following materials as fuel:

- wood
- treated wood (painted, lacquered, glued wood etc.);
- sawdust or chips
- liquid fuel
- coal or other fossil fuels
- plastic and derivatives
- treated paper and cardboard
- waste
- fuels that release toxic or polluting substances

Using these fuels, on top of being forbidden due to the emission of polluting and harmful substances, causes the stove to deteriorate more rapidly and debris to accumulate in the stove and in the smoke evacuation system, thereby reducing performance and safety.



The gases produced by these fuels are dangerous for the environment and for your health!



Using fuel that is not compliant with the above will void the warranty.

Automatic cleaning system

The stove is equipped with automatic brazier cleaning system. This means that there is no need to carry out daily manual cleaning of the brazier or every time the stove is lit. The automatic cleaning system is activated every time the stove is lit and after 6 hours of continuous operation. The cleaning cycle, which involves shutting down, automatic cleaning and restarting the stove, takes about 10 minutes. During this period the heating is guaranteed by the heat accumulated by the appliance itself.

Note: the times indicated are those set by default by the Manufacturer.

Recharge the fuel



Use only wood pellets, the characteristics shown in this manual.



During pellet loading prevent the pellet bag from coming into contact with hot surfaces.



It is not recommended to empty the pellet bag directly into the hopper to avoid depositing wood sawdust on the bottom of the hopper.

Doors opening

The combustion chamber door and the ash drawer can only be opened when the stove is in the OFF state.

If one of them is not closed, the pellet supply is interrupted, the control unit emits an acoustic warning signal, while the symbol appears on the display:

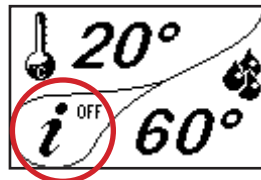

In this condition, by touching the CONFIRM button you can read the detail of the warning: “doors and ash pan open”. If the combustion chamber door and / or the ash drawer are not closed within 1 minute, the stove switches off signalling ALARM 07.

Opening the doors also interrupts the automatic cleaning phase of the brazier. In the event of a prolonged interruption of the cleaning phase, ALARM 19 may appear.

Remember that in the presence of an alarm the stove will have to be restarted manually.

User training

Once installation is complete, the user must always be fully trained in the functions and characteristics of the stove by the technician authorized by Ravelli to ensure optimal and safe use.

The training should cover the following topics:

- Description of the stove, its operation and basic settings
- How to turn the stove on and off safely
- Fuel storage and refilling
- What to do in the event of an alarm, in particular that of “no ignition”
- How to clean the stove correctly and the importance of performing it on a regular basis
- It is advisable to schedule the first annual maintenance

Safety devices

The stove has been designed and equipped with safety systems to minimize user risks.

It is equipped with the safety devices listed in the following table, which also intervene in case of failure of the electronic board.

Element	Description
Water temperature thermostat	If the water temperature exceeds the set safety value, it immediately stops the pellet loading motor and the stove is automatically switched off; to restart it, it is necessary to wait until it has cooled down and manually reset the thermostat, using the appropriate button.
Pressure switch	If the pressure in the smoke outlet duct is too high (a sign that the smoke evacuation system is obstructed) it immediately stops the pellet loading motor and the stove switches off automatically.
Limit switch for closing combustion chamber door, ash drawer and pellet hopper lid	If the door of the combustion chamber, the ash drawer or the pellet hopper lid are not properly closed, it immediately stops the pellet loading motor; if they are not closed within 60 seconds, the stove switches off automatically.
Safety valve for water overpressure	In the event of overpressure of the hydraulic system, the safety valve opens discharging water, so that the stove is not damaged.
Electrical safety	In case of failure of the electrical components or wiring, the fuse and grounding keep the appliance safe. It is necessary that the electrical system of the house is up to standard, equipped with a grounding circuit and all the safety systems required by the standards.

It should be noted that the stove's operating program has been designed to stop stove operation in the event of malfunctions:

Anomalies	Description
Temperature in the combustion chamber	If the temperature probe in the combustion chamber detects temperatures that are too high or too low, the stove is switched off and the relative alarm is displayed.
Flue gas temperature	If the temperature probe at the smoke outlet detects temperatures that are too high, the stove is switched off and the relative alarm is displayed.
Water over-temperature	If the water temperature in the boiler of the stove, detected by the appropriate probe, is too high, the stove is switched off and the relative alarm is displayed.
Water pressure	If the water pressure in the boiler of the stove, detected by the pressure transducer, is too high or too low, the stove is switched off and the relative alarm is displayed.
Smoke fan break	If the fan stops, the electronic board blocks the supply of pellets and the alarm is displayed.
Gear motor failure	If the gear motor stops, the appliance switches off safely.
Temporary power failure	If a power failure occurs during operation, when the power returns the temperature in the combustion chamber is checked and, if necessary, the stove goes into cooling mode.
No ignition	If no flame develops during the ignition phase, the stove goes into alarm.



It is forbidden to tamper with the safety devices. Restarting the product is only possible after eliminating the cause that caused the intervention of the safety system. To understand which anomaly occurs, consult this manual which explains, depending on the alarm message that the device displays, how to intervene on it.



If the problem persists, contact the Support Service.

SHIPPING AND INSTALLATION

Safety warnings for transportation and installation



The stove must be installed by a qualified technician, who must issue a declaration of conformity of the system to the purchaser, taking full responsibility for stove installation and correct operation.



The stove installation site must be chosen so that the generated heat can spread evenly throughout the rooms that you wish to heat.



The stove needs to be connected to a single chimney that guarantees the draught declared by the Manufacturer and observes the installation regulations that apply to the installation site.



The room where the stove is installed must have an air intake.



The air vent must be installed in such a way that it can not be blocked.

The Manufacturer will not be held liable for installation that is not compliant with the laws in force, incorrect air circulation in the rooms and inappropriate use of the appliance.

In particular, it is necessary:

- that the appliance be connected to a smoke evacuation system duly sized to guarantee the draught declared by the Manufacturer, that is tight and observes the distances from flammable materials;
- that there is a suitable combustion air intake in compliance with the type of installed product;
- that other installed combustion appliances or devices do not create a vacuum in the room where the stove is installed;
- that the safety distances from flammable materials are observed.

Verification of system compatibility has a priority over any other assembly or installation operation.



Local administrative regulations and particular requirements of the authorities pertaining to the installation of combustion appliances, the air intake and the smoke evacuation system, may vary based on region or nation. Check with your local authorities if there are stricter laws than set forth herein.

Packaging

When the stove arrives, check:

- that it is the model you ordered;
- that it has not been damaged during shipping.

Any complaints must be reported to the deliveryman (also on the delivery note) upon receipt.



Check the capacity of the floor before handling and positioning the stove.

To handle the stove in its packaging, follow the procedure below:

- 1 Position the pallet truck forks in the slots under the wooden pallet.
- 2 Lift slowly.
- 3 Place the stove near the chosen location for installation.



The stove always needs to be handled vertically. Take extra care to protect the door and its glass against mechanical impact that could jeopardise their integrity.

To unpack the stove, follow the procedure described below:

- 1 Cut the straps and remove the wooden reinforcement frame resting on the box
- 2 Slowly lift the cardboard box
- 3 Remove any bubble-wrap or similar
- 4 Remove the stove from the pallet and position the appliance in the chosen location, ensuring that it is compliant with the directions.



The end user is responsible for disposing of the packaging in accordance with the laws in force in the country of installation.

Set-ups for the smoke evacuation system



Be careful when building the smoke evacuation system and observe the regulations in force in the country where the stove is installed.



The Manufacturer will not be held liable for incorrectly sized and non-regulation smoke evacuation systems.

Smoke ducts and fittings

The term smoke duct indicates all ducts that connect the combustion equipment to the chimney.

The following requirements need to be applied:

- observe product standard EN 1856-2;
- the horizontal sections must have a minimum slope of 3% upwards;
- the length of the horizontal section must be as minimum as possible, and its projection on the horizontal plane must not exceed 2 metres;
- changes in direction must not have an angle of more than 90° (45° bends are recommended);
- the number of direction changes, including the one necessary for insertion into the chimney, must not exceed 3;
- the cross section must have a constant diameter, the same from where it exits the firebox up to the fitting into the chimney;
- it is forbidden to use flexible metal and fibre cement pipes;
- smoke ducts must not cross rooms where the installation of combustion equipment is prohibited.

In any case, the smoke ducts must be sealed against combustion products and condensation, as well as insulated if they lead outside of the installation room.

Installing manual draught adjustment devices is not allowed.

Chimney

The chimney is a particularly important element for correct stove operation.



The chimney must be sized so as to guarantee the draught declared by the Manufacturer.



Do not connect the stove to a collective chimney.

The chimney must be built applying the following regulations:

- it must observe product standard EN 1856-1;
- it must be made of materials that are suitable to guarantee resistance against normal mechanical, chemical and thermal stress and be correctly thermally insulated to limit the formation of condensation;
- it must be mainly vertical and not feature any bottlenecks along its entire length;
- it must be correctly spaced with an air gap and insulated from flammable materials;
- there must be a maximum of 2 changes in direction and angles must not exceed 45°;
- the chimney inside the home, however, must be insulated and can be inserted into a skylight shaft, as long as it respects standards regarding placing inside a tube;
- the smoke conduit must be connected to the chimney using a "T" fitting with an inspection collection chamber for combustion residue and especially for collecting condensation.



It is necessary to check the safety distances that need to be observed when there are flammable materials and the type of insulating material that needs to be used is on the chimney data plate.



Use watertight pipes with silicone seals.



It is forbidden to use the discharge mounted directly on the wall or directed towards indoor spaces and any other type of discharge that is not set forth by the regulation in force in the country of installation (Note: in Italy only roof-discharge is allowed).

Chimney pot

The chimney pot, i.e. the top end of the chimney, must fulfil the following characteristics:

- the cross-section of the smoke outlet must be at least twice the internal cross-section of the chimney;
- it must stop water or snow from getting in;
- make sure the smoke is taken away even when there is wind (wind resistant chimney pot);
- the outlet height must be outside of the reflux zone (refer to national and local regulations to calculate the reflux zone);
- it must always be built at a distance from antennas or dishes, it must never be used as support.

Installation

 For appliance installation and use it is necessary to observe all of the local, national and European laws and regulations.

 Stove installation and the preparation of the building work must observe the regulation in force in the country of installation (ITALY = UNI 10683).

 The installation activities must be carried out by a technician that is qualified and/or authorised by the Manufacturer. The staff in charge of installation must issue a declaration of conformity of the system to the buyer, whereby they take full responsibility for the final installation and good operation of the installed product.

 Ravelli shall not be held liable if these precautions are not followed.

Requirements for the installation premises

The stove installation room must be sufficiently ventilated. To fulfil this requisite it is necessary to equip the room with an air intake connected to the outdoors.

 The installation room must have an air intake with a free cross-section of at least 80 cm².

 For installation in the presence of other combustion appliances or VMC system it is necessary to check the appliance for correct operation.

The stove must be placed inside living quarters. It must never be installed outdoors. The volume of the room where it is installed must be suitable for the power of the appliance and, in any case, greater than 15 m³.

 When extraction fans (example: extraction hoods) are used in the same room or space as the stove, this can cause problems to stove operation.

 The stove must be installed on a floor with suitable load capacity. If the existing position does not fulfil this requirement, it is necessary to take due measures (for example, using a load distribution plate).

 Provide due insulation if the surface is made of flammable material.

If the side walls adjacent to the stove are made of a flammable material, it will be necessary to position the stove at least 30 cm from them.

If the floor that the stove is standing on is flammable, we recommend duly insulating it. Objects and parts that are heat-sensitive or flammable cannot be stored near the stove; in any case, keep such objects outside the area bounded by the minimum distances indicated above.

Stove installation must guarantee easy access to clean the appliance, the exhaust ducts and the chimney.

Installation example for a stove/pellet stove

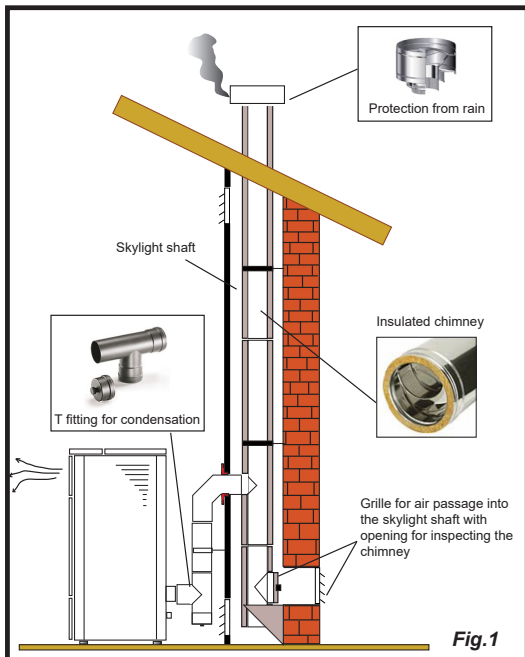

This type of installation (See Fig.1) requires an insulated chimney pot, even if the entire conduit is installed inside the building. Besides, the structure must be inserted into a properly ventilated skylight shaft.

In the lower part of the chimney pot there is an inspection cover, properly isolated from wind and rain.

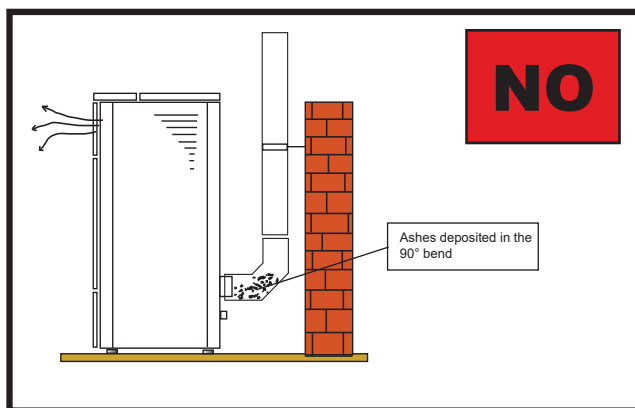

It is prohibited to install a 90° bend for the initial segment, since the ashes would quickly obstruct smoke passage, causing draught problems in the stove. (See Fig. 2)

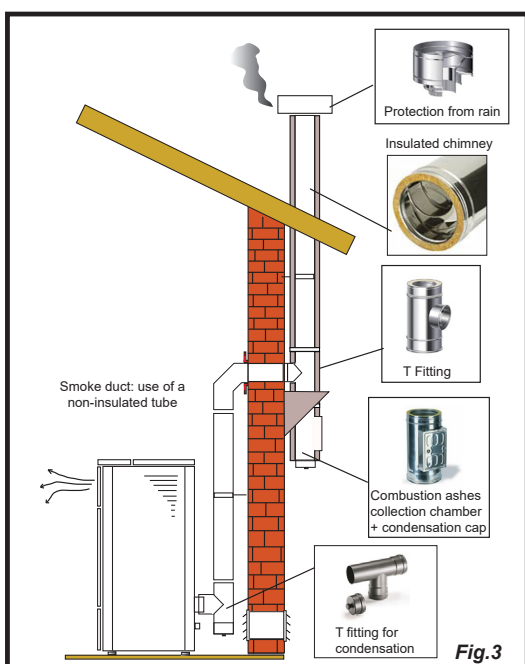

It is possible to use an existing chimney or a shaft via ducting. For this type of installation the standards on ducted smoke evacuation systems must be complied with. In the lower part of the chimney pot, inside the home, there is a "T" type fitting installed; externally there is another one installed, so that the outside section can be inspected.

It is prohibited to install two 90° bend, since the ashes would quickly obstruct smoke passage, causing draught problems in the stove. (See Fig. 2)

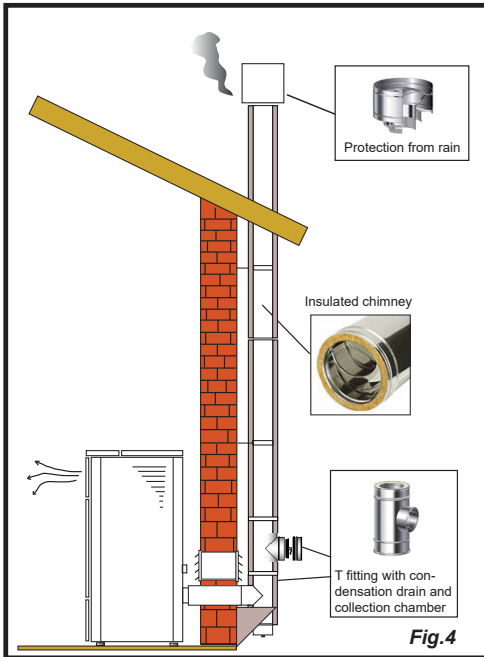

This type of installation (See Fig.4) requires an insulated chimney pot, even if the entire smoke conduit is installed outside the building.

In the lower part of the chimney there is a "T" type fitting installed with inspection cap.

It is prohibited to install a 90° bend for the initial segment, since the ashes would quickly obstruct smoke passage, causing draught problems in the stove. (See Fig.2)

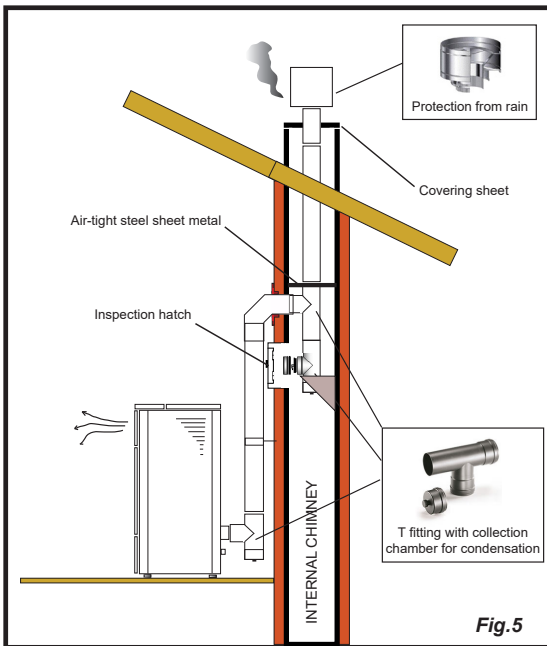

This type of installation (See Fig.5) requires an insulated chimney pot, since the entire smoke conduit is installed inside the building, and the part is located inside a pre-existing chimney pot.

In the lower part of the stove there is a "T" type fitting installed with inspection cap just like for the chimney pot.

It is prohibited to install a 90° bend for the initial segment, since the ashes would quickly obstruct smoke passage, causing draught problems in the stove. (See Fig.2)

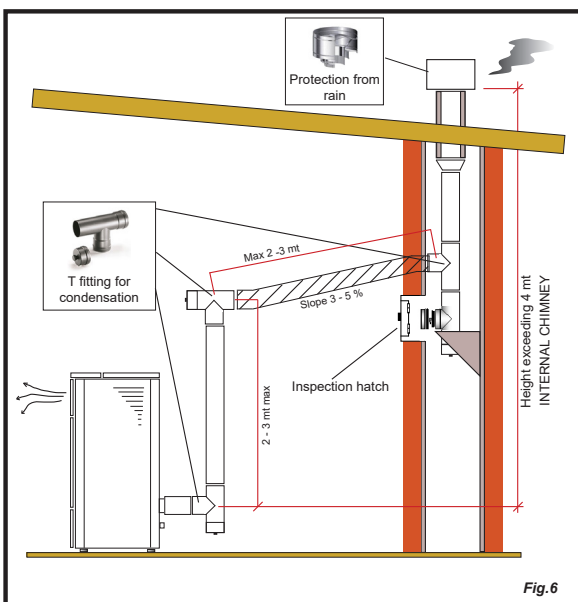

This type of installation (See Fig.6) requires a horizontal section to connect to a pre-existing chimney pot.

Respect the slope indicated in figure, in order to reduce the ashes depositing in the horizontal tube. In the lower part of the chimney pot, there is a "T" type fitting installed with inspection cap, in the same way as the chimney pot opening.

It is prohibited to install a 90° bend for the initial segment, since the ashes would quickly obstruct smoke passage, causing draught problems in the stove. (See Fig.2)

CONNECTIONS



The connections must be set up by a technician that is qualified and/or authorised by the Manufacturer.



By the installer the type of cable, with relative section, to be installed in case of replacement is: H05RR-F sez.3G0,75

Chimney connection



The chimney must be sized so as to guarantee the draught declared by the Manufacturer.



The stove must be connected to a single flue. It is forbidden to connect the stove to a flue shared with other combustion appliances or with hood exhausts.



The flue must be inspectable for cleaning.

Components

This stove is equipped with the following control and safety components:

- 3 bar safety valve;
- Booster pump control thermostat (integrated in the functions of the electronic board);
- Acoustic alarm activation thermostat (integrated in the functions of the electronic board);
- Temperature indicator (integrated in the functions of the electronic board, with display);
- Pressure indicator (integrated in the functions of the electronic board, with display);
- Acoustic alarm (integrated in the functions of the electronic board);
- Automatic regulation thermal switch (integrated in the functions of the electronic board);
- Automatic blocking thermal switch (manual reset thermostat);
- Circulation system;
- Expansion system (Expansion vessel).

Local laws and regulations (for example the UNI 10412-2 standard valid in Italy) could provide for other safety components. In this case they must be mounted in the system.

The construction of a heating system with the relative installation of the boiler must comply with all national and local regulations in force in the place where the system is carried out.

Stove-system connection

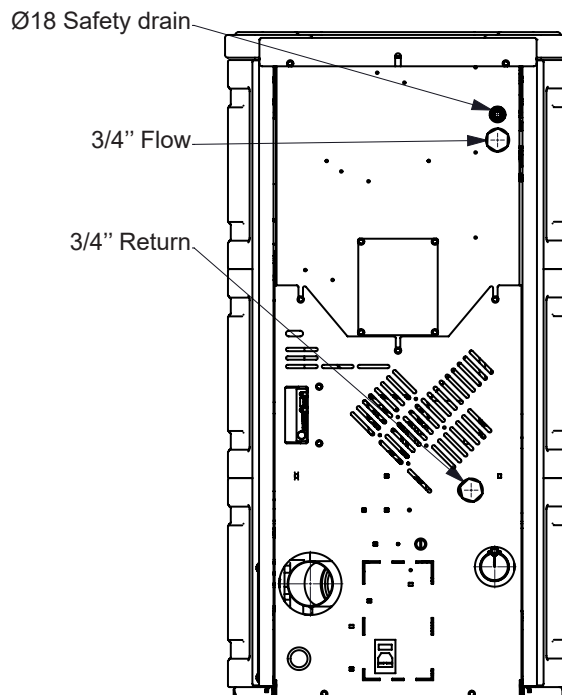

Connect the stove to the hydraulic system so as not to constrain it excessively and to allow it to move slightly.



Before connecting the thermo-stove, it is strongly recommended that the system be thoroughly washed in order to eliminate residues and deposits.

Electrical connection

The plug of the stove's power cable must only be connected after the installation and assembly has been completed of the appliance, and must remain accessible after installation.

To make the electrical connection, proceed as described below:

First connect the power cable to the plug on the back of the stove and then to a wall socket.

Supply power to the stove by turning the switch to position (I).



When the stove is not in use, it is advisable to disconnect the power cable.



Take care that the power cord (and any other cables outside the equipment) do not come into contact with hot surfaces.



Ensure that the electrical system is grounded.



For direct connection to the mains, it is necessary to provide a device that ensures disconnection from the mains, with a contact opening distance that allows complete disconnection under the conditions of over-voltage category III, in accordance with installation rules



If the power supply cable is damaged, it must be replaced by the manufacturer or its technical assistance service or in any case by a person with similar qualifications, so as to prevent any risk.



It is recommended that authorized personnel pay special attention to the electrical connections after any work on the product.

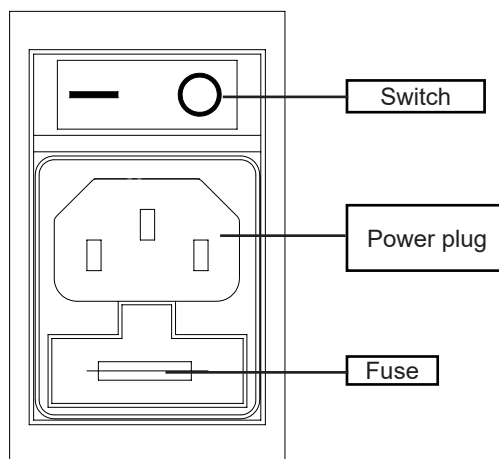

Connection of external probe or thermostat

To manage the ducting in automatic mode, connect a temperature probe (optional) or external thermostat (optional) to the connector.



Connect an open/closed external thermostat, therefore potential-free.



If you wish to detect the ambient temperature by means of an external thermostat (optional), this must be connected to the appropriate connector on the rear side of the stove; and you will have to activate the reading in "SETTINGS - ENABLE THERMOSTAT." On display appears the writing TON / TOFF based on thermostat request.



Connect an external thermostat with a simple dry contact, therefore, not powered, moreover, we recommend you use a thermostat with a minimum offset of 3°C if you intend to use the "comfort clima" function.

Testing and commissioning

Stove start-up must be preceded by testing, which includes an operational check of the following elements:

- connection to the smoke evacuation system;
- electrical connections;
- hydraulic connections;
- operation of any connected external probes;
- checking that all materials used to build the smoke duct, chimney and chimney pot are regulation and suitable for use.

The testing is positive only when all operational phases have been completed without any anomaly being detected.

Electric scheme

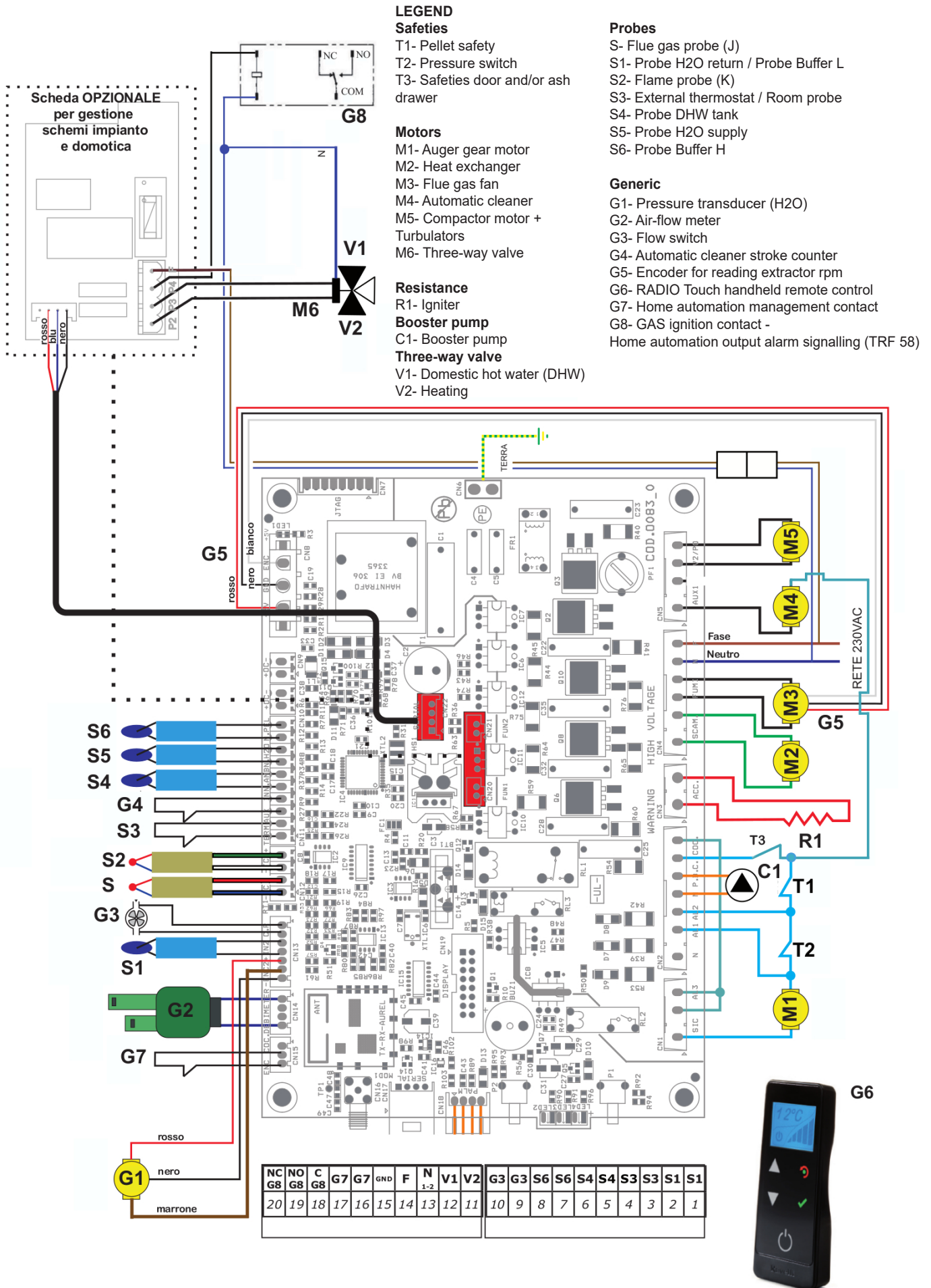

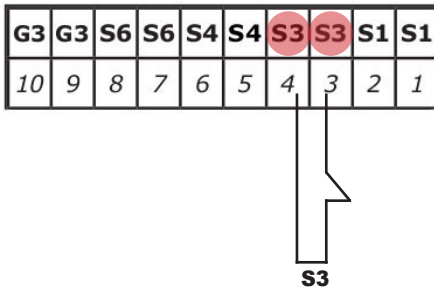
Connections for hydraulic diagrams
Connections for diagram 0 (heating system only)

Connections for diagram 0 and DHW Kit

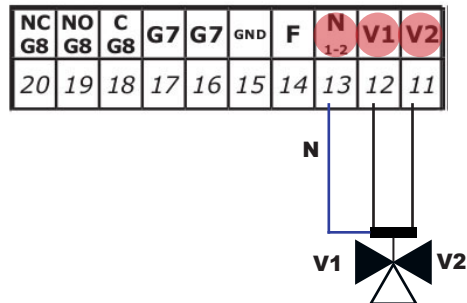
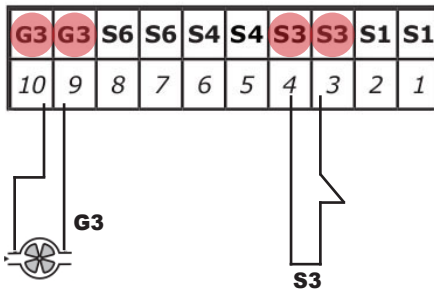

The optional kit is required to use this diagram

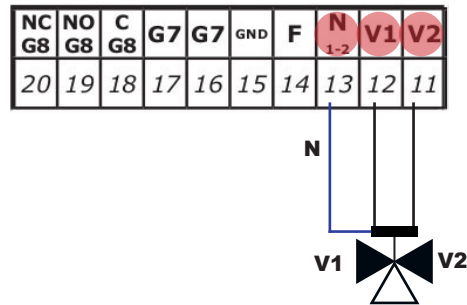
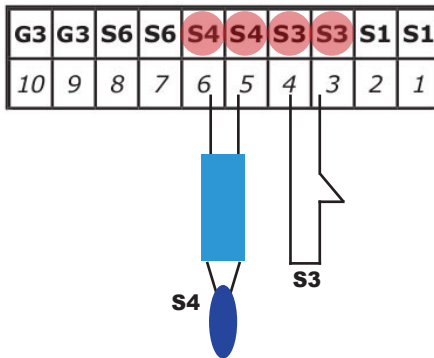
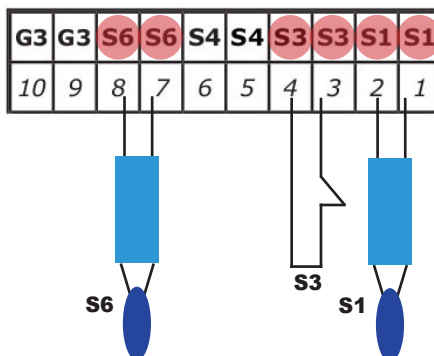

Connections for diagram 1 (boiler)

The optional kit is required to use this diagram

Connections for diagram 2 (buffer tank)

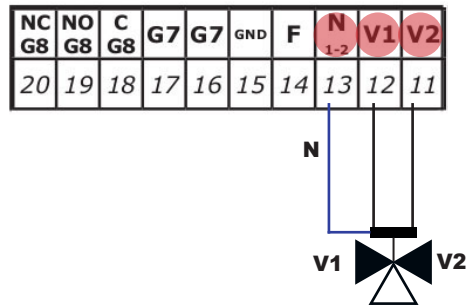
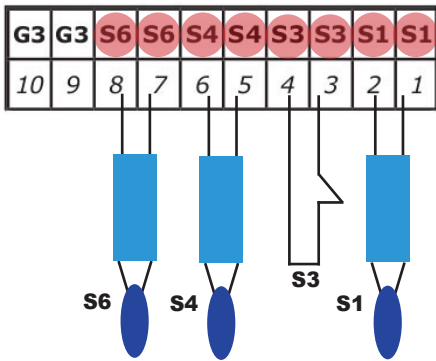

Connections for diagram 3 (boiler + buffer tank)

 The optional kit is required to use this diagram



Connections for home automation and gas boiler

For all schemes to use the home automation contact or the gas boiler contact

 Optional kit is required

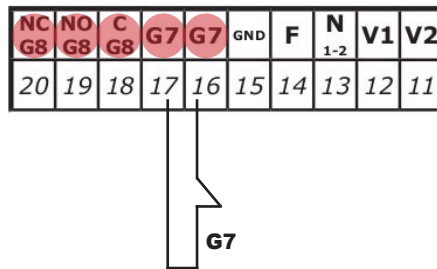

PLUMBING SYSTEM CONNECTIONS



Plumbing must always be carried out by qualified personnel, able to carry out a state-of-the-art installation in compliance with the laws in force in the country of installation, after having read the next chapter. Ravelli denies all liabilities for damages to people or property arising from malfunctions due to failure to comply with this warning.

Installation advice

The heating system must be sized appropriately based on the power of the boiler. If necessary, rely on a thermo-technician. After placing the stove and installing all fume exhaust pipes, you can connect the hydraulic system. It is recommended to connect the stove to the system by means of ball valves or gate valves, in order to enable easy detachment, if needed.

3 bar safety valve (overpressure device)

It is mandatory to connect the safety drain of the thermo-stove to an adequate evacuation system. The connection can be made using a rubber hose resistant to temperatures of at least 110 ° C.

Please note that in case of intervention of the 3 bar safety valve, part of the water contained in the system is expelled from the safety drain.



It is forbidden to connect a shut-off valve to the safety drain outlet.



The water coming out of the safety valve could be hot! Danger of burns and damage to people and things!



The manufacturer is not responsible for any damage to persons or things caused by failure to connect the safety drain or by an inadequate connection.

Expansion vessel

Check that the expansion vessel fitted as standard on the stove is sufficient for the volume of water contained in the system. Otherwise it will be necessary to install an additional expansion vessel on the system.

Anti-condensation valve

In solid fuel stoves, to avoid the return of cold water in the heating chamber during the heating phase, it is advisable to install in the system an AUTOMATIC THERMOSTATIC VALVE (available on request) to improve combustion efficiency and stove life and also reduce the condensation of fumes in the flue ways, with less deposits and tars.

Storage systems (puffer, boiler)

Solid fuel appliances are, by their nature, devices with high thermal inertia. To increase the heat output of the system, reduce the on / off cycles, reduce cleaning interventions and have hot water always available, it is recommended to install thermal accumulators in the system, such as puffers for technical water or boilers for domestic hot water. There are many combined solutions on the market (puffer tank in tank, pipe in tank, etc.), which allow to meet all needs.

Hydraulic diagrams

With this thermo-stove, different types of system can be handled - both those where thermo-stoves are directly connected to heating circuits, and more complex systems with accumulators (Boilers, Buffer tanks or both) for DHW production. The hydraulic diagram to be used must be chosen via the display by an authorised technician when the thermo-stove is installed.

Diagram 0 (heating system only)

In this type of circuit, the stove is directly connected to the heating system. This is the default set diagram.

LEGEND

- | | | |
|----------------------------|--|-----------------------------|
| 1- Pellet stove | 7- Check valve | 13- Power separation system |
| 2- Distribution manifolds | 8- Group of direct distribution | 14- Gas boiler |
| 3- Radiators | 9- Thermostatic distribution unit | |
| 4- Thermometer | 10- Radiant panel (underfloor heating) | |
| 5- Pressure gauge | 11- Shut-off valve | |
| 6- Anti-condensation valve | 12- Thermostat | |

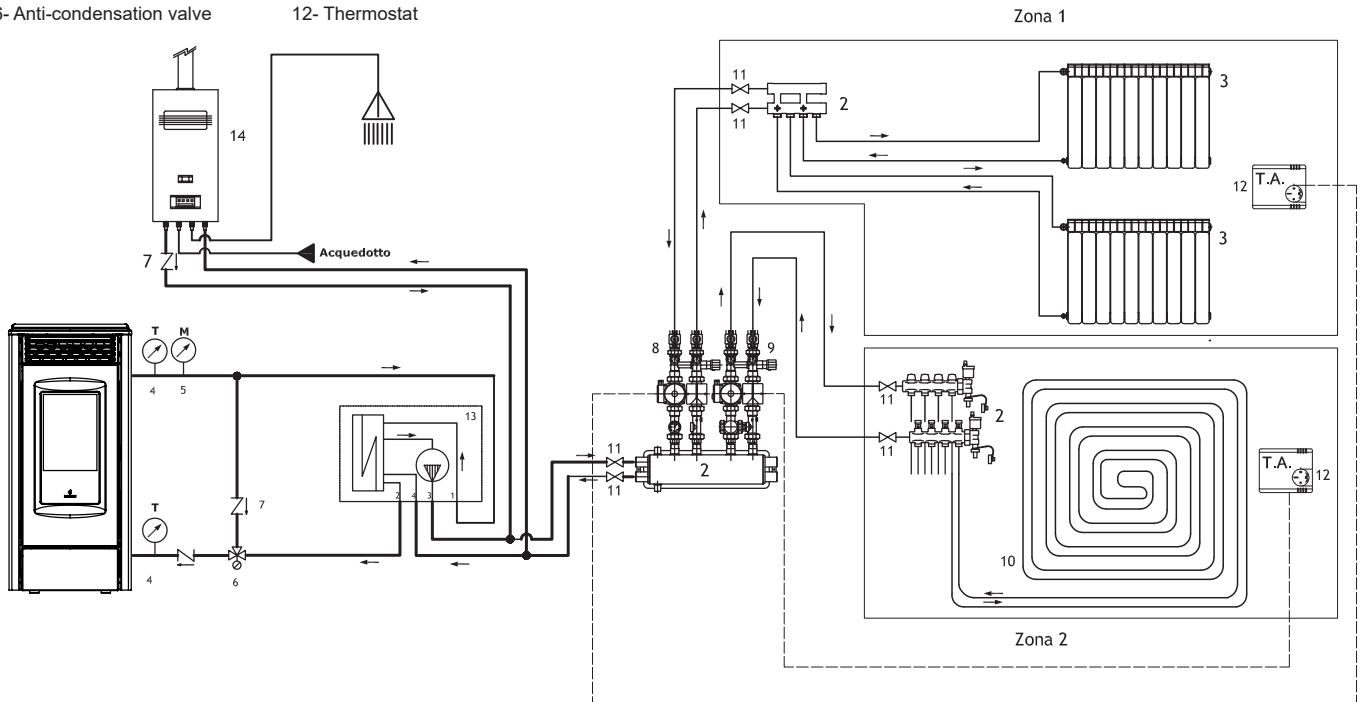

The diagram shown here is indicative and may not display all the components required to properly operate the system. Rely on a qualified thermal technician for the hydraulic system design.

NOTE: The DHW KIT can also be used in this diagram

Diagram 1 (boiler sensor)

Diagram 1 allows operating a heating system where there is also a boiler for DHW production. The boiler can be connected to other heat production units, such as solar panels.

With this diagram, the stove operates to bring the boiler to the set temperature; when the set water temperature is reached, the three-way valve changes position and the thermo-stove begins to exchange heat in the heating system. From now on, the boiler is operated by an external thermostat or by the internal H2O set (as in diagram 0). The thermo-stove reheats the boiler once the boiler water temperature has fallen below the set-point value or when the flow switch (if connected) detects DHW being used.

If the thermo-stove is in ECO STOP mode or in WATER STAND-BY mode, a request by the Boiler of flow meter is added to diagram 0 standard start-up conditions.

LEGEND

- | | | | |
|----------------------------|--|---|--|
| 1- Pellet stove | 7- Check valve | 13- Expansion vessel (tank) | 19- Motorised three-way valve with spring return |
| 2- Distribution manifolds | 8- Group of direct distribution | 14- Pump station for solar thermal system | 20- Flow switch |
| 3- Radiators | 9- Thermostatic distribution unit | 15- Solar thermal collector | 21- DHW storage |
| 4- Thermometer | 10- Radiant panel (underfloor heating) | 16- Thermostatic mixing valve | 22- Gas boiler |
| 5- Pressure gauge | 11- Shut-off valve | 17- Power separation system | |
| 6- Anti-condensation valve | 12- Thermostat | 18- Motorised three-way valve | |

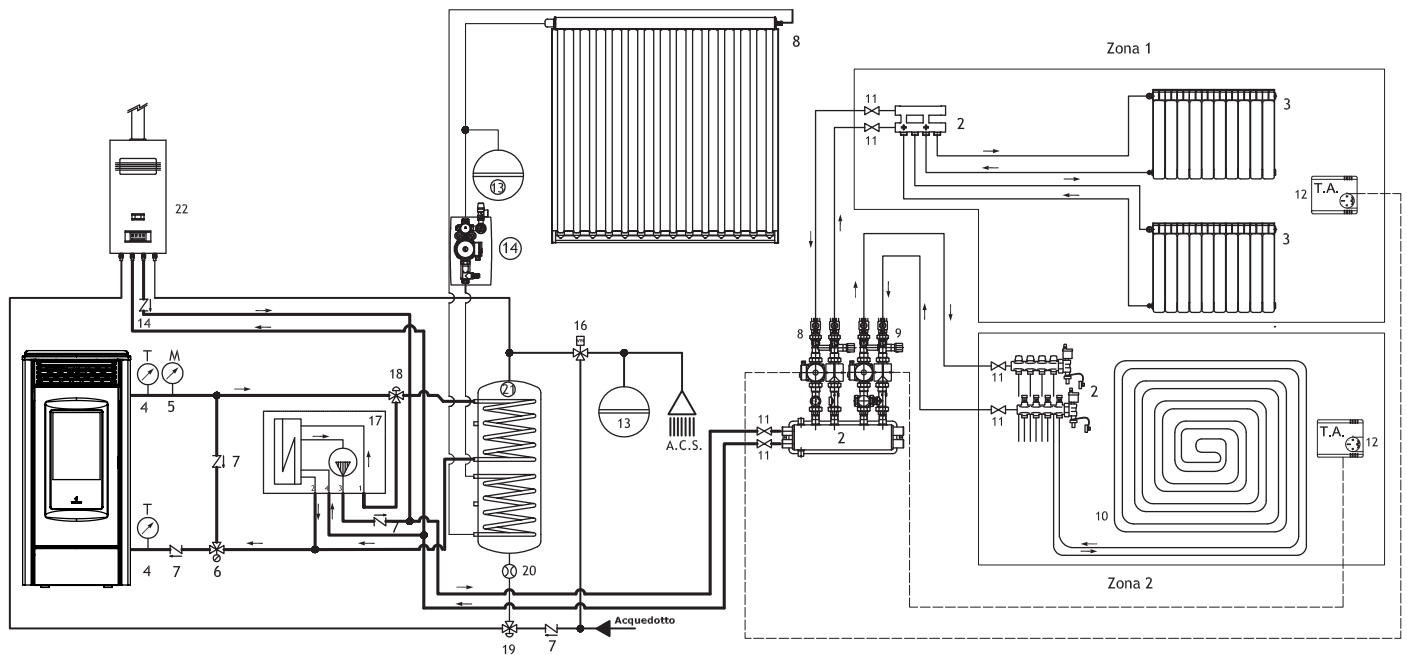

The diagram shown here is indicative and may not display all the components required to properly operate the system. Rely on a qualified thermal technician for the hydraulic system design.

Diagram 2 (buffer tank sensor)

Diagram 2 can be used in a system where there is a buffer tank that operates the heating system and, if pre-set, also DHW production. In this system, the thermo-stove is directly connected to the buffer tank.

In this type of circuit, room temperature is managed by a control unit (not supplied) that controls the buffer tank and any zone valves. The buffer tank temperature is controlled by the thermo-stove through a sensor.

The thermo-stove operates at maximum power to reach the set buffer tank temperature. When it is reached, the stove enters ECO STOP mode and is automatically restarted if the buffer tank temperature falls below this value. The advantage of using a buffer tank is that it regulates the operation of the thermo-stove. The buffer tank can be connected to other heat production units, such as solar panels and/or gas boiler.

LEGEND

- | | | | |
|----------------------------|--|---|--|
| 1- Pellet stove | 7- Check valve | 13- Expansion vessel (tank) | 19- Motorised three-way valve with spring return |
| 2- Distribution manifolds | 8- Group of direct distribution | 14- Pump station for solar thermal system | 20- Gas boiler |
| 3- Radiators | 9- Thermostatic distribution unit | 15- Solar thermal collector | |
| 4- Thermometer | 10- Radiant panel (underfloor heating) | 16- Thermostatic mixing valve | |
| 5- Pressure gauge | 11- Shut-off valve | 17- Booster pump | |
| 6- Anti-condensation valve | 12- Thermostat | 18- Buffer tank pipe in tank with DHW | |

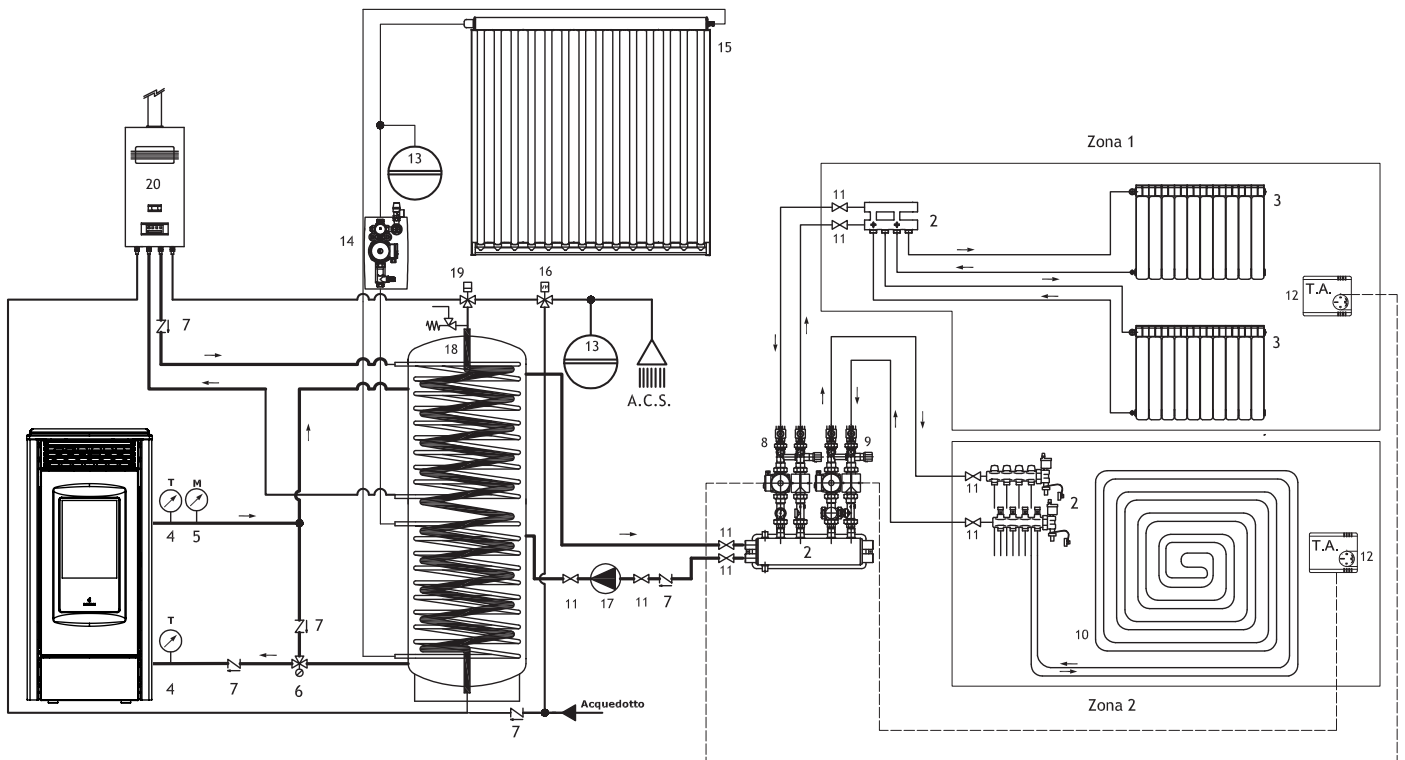

The diagram shown here is indicative and may not display all the components required to properly operate the system. Rely on a qualified thermal technician for the hydraulic system design.

Diagram 3 (boiler sensor + buffer tank sensor)

Diagram 3 is to be used in a system where both a water buffer tank for the heating system and a DHW boiler are present. The operating logic is similar to that of Diagram 1. Also in this type of circuit, the boiler water temperature is managed by the stove and room temperature by a control unit (not supplied) that controls the buffer tank and any zone valves. The buffer tank temperature is controlled by the thermo-stove through a sensor.

LEGEND

- | | | | |
|----------------------------|--|---|--|
| 1- Pellet stove | 7- Check valve | 13- Expansion vessel (tank) | 19- Motorised three-way valve with spring return |
| 2- Distribution manifolds | 8- Group of direct distribution | 14- Pump station for solar thermal system | 20- Gas boiler |
| 3- Radiators | 9- Thermostatic distribution unit | 15- Solar thermal collector | 21- Power separation system |
| 4- Thermometer | 10- Radiant panel (underfloor heating) | 16- Thermostatic mixing valve | 22- Motorised three-way valve |
| 5- Pressure gauge | 11- Shut-off valve | 17- Booster pump | 23- DHW storage |
| 6- Anti-condensation valve | 12- Thermostat | 18- Buffer tank | 24- Flow switch |

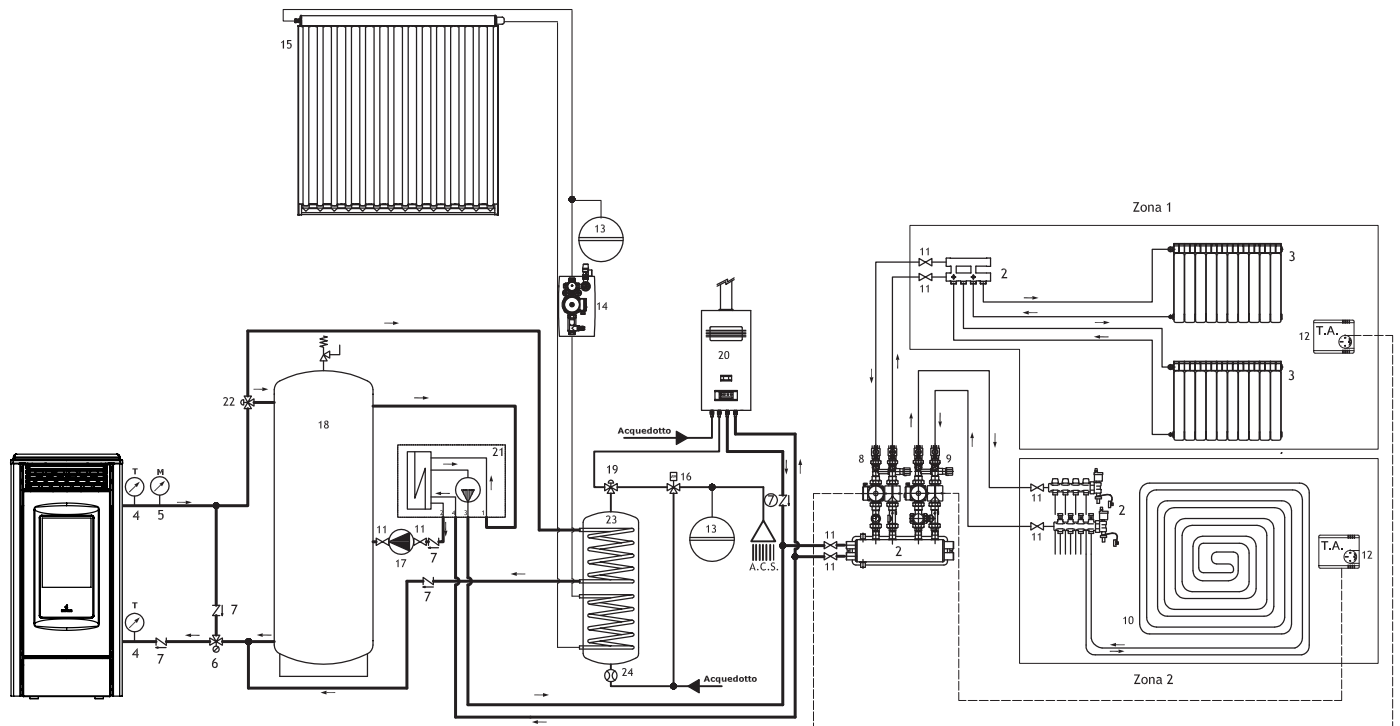

The diagram shown here is indicative and may not display all the components required to properly operate the system. Rely on a qualified thermal technician for the hydraulic system design.

System water characteristics

The chemical-physical characteristics of the system and replenishing water are important for the proper operation and service life of the thermo-stove; in fact, with the use of low quality water the most frequent problem is due to scale, which causes a reduction in heat exchange and generates corrosion.

Therefore, we invite you to check the quality and hardness of the water with your supplier.

We recommend the installation of a softener (limescale filter) in correspondence with the system loading. This precaution becomes essential in the conditions listed below:

- medium and high water hardness (> 15 ° f)
- considerable quantities of make-up water or subsequent fillings
- plants of a certain complexity and size.



National and local laws may require the use of water softening systems. The technician responsible for the plumbing installation is invited to check what is reported in the regulations in force.

System water load

Once the plumbing connections have been completed, the appliance and its system can be LOADED.

To facilitate the escape of air, unscrew the cap of the automatic vent valve (Jolly valve) of the thermo stove and open the vent valves in the system. Bleed the air even after the first hours of operation and, if necessary, also periodically (for example in the event of noises and gurgling).

The filling pressure of the COLD system must be 1 bar (100 kPa). In order to ensure correct operation of the thermo stove, the HOT pressure must be approximately 1.5 bar (150 kPa).

If during operation the system pressure drops to values below the minimum indicated above, the user must bring it back to the initial value by acting on the filling tap.

It is possible to load the system and keep it at the correct pressure also by means of a special automatic filling unit.

Periodically check the system water pressure, using the appropriate function on the display.

CONTROLS AND USE

Control panel description

The stove is controlled by an electronic card that allows fully automatic and controlled combustion. It allows to regulate the ignition phase, the power levels and the shutdown phase, guaranteeing safe operation. On the back of the stove there is a control panel that allows you to synchronise the electronic discharge with the handheld computer and turn the stove on/off.

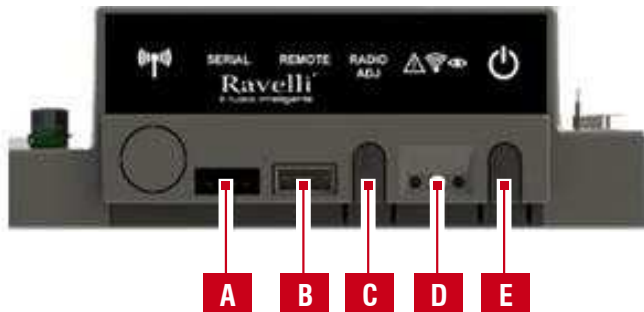

A	Serial socket
B	Handheld cable connection socket
C	ADJ Radio: button to connect the handheld to the card
D	Signaling Led Red: active allergy Yellow: Awaiting communication with the handheld Green: Stove on
E	Stove on/off button

Handheld touch radio initialization

The handheld, after a first short screen showing the Ravelli logo, will list the languages available in the menu. Select the desired language with the scroll buttons and confirm your selection with the confirmation button.



In order to operate correctly, the handheld set should be interfaced with the electronic board installed inside the stove. For this reason, on display appears the following message:



If the handheld set is used for the first time, select YES using the selection keys and confirm with the dedicated key. On the display of the handheld set appears the following:



The flashing yellow LED indicates that the circuit board is waiting to receive the signal from the handheld set.

By pressing the enter key on the handheld set, the components start communicating with each other. A check sign on the display, accompanied by a sound signal, shows that the initialization of the handheld set has been completed successfully



In case of battery replacement, it is not necessary to perform the initialization procedure of the handheld computer. In this case, when the display will show the message "FIRST INSTALLATION ?", select NO and press the dial key.

Description of the handheld set

The PDA looks like the following picture:

The information below will familiarize you with the product and give you the best performance.

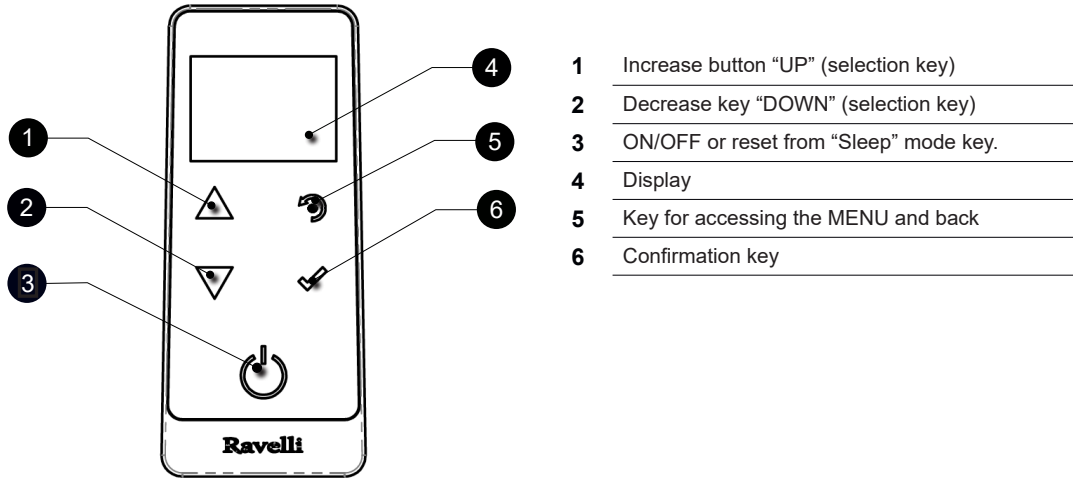

The display backlight turns off after a few moments when the handheld is not used. It is activated again with the first press of any key.



After a further time of inactivity, the display goes into "SLEEP" mode and the handheld screen is deactivated in order to reduce battery consumption, while maintaining radio communication with the stove active. Pressing the ON / OFF key reactivates the display.



There is an ambient probe integrated in the handheld. Keep the PDA in a suitable place to measure the real temperature of the room to be heated (not too close to the stove or a source of heat or cold).

How to insert the batteries in the handheld set

Remove the protective cover of the battery on the back of the remote control as shown in Figure A, and insert the 3 batteries (mini pen style battery AAA 1.5V) in the housing of the handheld set and observe the poles. Install the battery protective cover as shown in figure B. The handheld, after a first short screen showing the Ravelli logo, will list the languages available in the menu.



Figura A



Figura B

What happens if the batteries are empty

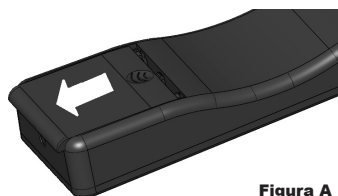
If the battery is discharged, within the "drop" is shown a symbol that indicates that the battery is empty, while maintaining active the features of your device.

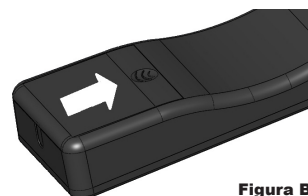

As soon as the level of the battery prevents the radio communication the handheld set displays on full screen the picture of empty battery and all device functions are locked until the batteries are replaced.

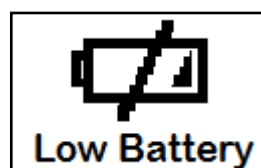

If not in use for a long time, we recommend removing the batteries from the remote control.

PROCEDURES FOR USE

 If the chimney catches fire you must call the fire brigade immediately.

Checks prior to start-up

 You have read and perfectly understood the contents of this instructions manual.

Before lighting the stove, you must ensure that:

- the pellet tank is full;
- the combustion chamber is clean;
- the fire door and ash drawer seals are functioning properly;
- the electrical plug is connected correctly;
- all items that could burn (instructions, various adhesive labels) have been removed;
- the brazier, if removable, is correctly positioned in its housing;
- the hydraulic system valves are open properly.

 During the first hours of use the paints used for the stove finish may release an unpleasant odour. You might also smell the typical odour of metal parts subject to high temperatures. Make sure sufficient air circulation is guaranteed in the room. These unavoidable inconveniences will disappear after the first hours of operation. To reduce your discomfort to a minimum, keep the stove on for a few hours on low power and in the beginning, do not overload it, avoiding intense heating-cooling cycles

 At the initial start-up, the paint finishes drying and hardens. Accordingly, to avoid ruining it, we advise you not to touch the stove's painted surfaces at this time.

Feed screw loading

Before starting the stove for the first time, whenever the stove is in alarm "06 - Pellets finished", and in any case whenever the hopper has emptied completely, the initial feed screw loading is required.

This phase serves to fill the pellet loading system so that, at the time of ignition, the correct pellet loading takes place in the brazier. In the event that the feed screw operations are not carried out, there may be stove ignition failures.

 After loading the auger and before lighting the stove, always remember to empty the brazier and check that the brazier is clean. Never empty the brazier inside the hopper.

 After each maintenance operation, make sure that the brazier is positioned correctly in its seat.

 In models with self-cleaning brazier it is not necessary to remove the pellets in the brazier: the pellets loaded are sufficient for subsequent ignition.

By accessing the USER menu and then the LOADING AUGER menu, by pressing the confirmation key, the rotation of the auger is activated to load the pellets into the brazier.

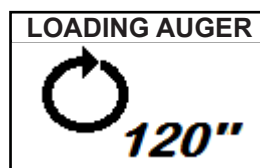

Switching the appliance on and off

From the "Home" screen, it is possible to switch the stove on and off by keeping the ON / OFF button  pressed on the device for a few seconds. An acoustic signal will warn you that the appliance has switched on or off. In case it is not possible using your handheld you can switch the appliance on / off using the appropriate button on the electronic board.

 Do not switch off the heater by unplugging the plug from the wall socket.

 The appearance of the "SET RDS" message indicates that the initial parameter testing and calibration procedure was not carried out correctly. This indication does not imply blocking the stove (see SIGNALLING POP UP section).

Failed ignition

If the system does not detect the ignition of the flame within the preset time, operation will be blocked with the "No ignition" alarm. Before relighting the stove, check that there are pellets in the hopper, that the door and ash drawer compartment are closed, that there are no obstructions to the combustion air inlet system and above all that, in models without self-cleaning brazier, the brazier is empty, clean and correctly positioned. If the problem persists, it could be due to a technical problem (ignition plug, adjustments, etc ...), so please contact a Ravelli CAT.

 The accumulation of unburned pellets in the brazier after a failed ignition must be removed before proceeding with a new ignition.

 The brazier could be very hot: danger of burns!

 Never empty the brazier inside the hopper.

 In stoves with self-cleaning brazier it is sufficient to reset the alarm and turn the stove back on: before loading more pellets, the stove will try to light any pellets already present in the brazier.

Setting operating temperature and power:

Set the two values following the indications given in the chapter "Description of the display"

Description of the display and temperature adjustment

The Home screen of the handheld display appears differently depending on the hydraulic scheme set during the installation phase.

Diagram 0 (heating system only)

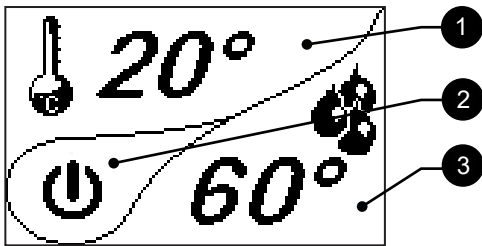

1. Indicates the room temperature measured by the handheld device (if the external thermostat is connected, it indicates whether it requires ignition with ON t.ext or stove shutdown with OFF t.ext);
2. Icon indicating the status of the stove;
3. Indicates the temperature of the water in the thermo stove.

You can change the room temperature set by tapping the UP arrow key. In this way this part of the display is highlighted and the currently set temperature is shown. With the UP and DOWN arrow keys it is possible to modify this value. The confirmation of each change takes place automatically within 3 seconds of the change or by pressing the confirmation button. An acoustic signal certifies the change.

You can change the water temperature set by tapping the DOWN arrow key. In this way this part of the display is highlighted and the currently set temperature is shown. With the UP and DOWN arrow keys it is possible to modify this value. The confirmation of each change takes place automatically within 3 seconds of the change or by pressing the confirmation button. An acoustic signal certifies the change.

Diagram 1 (boiler sensor)

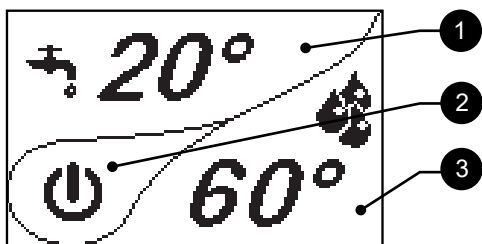

1. Indicates the temperature of the DHW tank to be maintained (if the thermostat is connected to the tank, it indicates whether it requires heating the domestic water with ON t.ext. or not with OFF t.ext.);
2. Icon indicating the status of the stove;
3. Indicates the temperature of the water in the thermo stove.

It is possible to change the DHW temperature set and the room temperature set by touching the UP arrow key. This will take you to a new screen which shows the temperatures currently set.

With the UP arrow key you activate the modification of the room temperature (room set) and with the UP and DOWN arrow keys you can modify this value. Confirmation of any changes takes place automatically.

With the DOWN arrow key you activate the modification of the DHW temperature (set boiler) and with the UP and DOWN arrow keys it is possible to modify this value. Confirmation of any changes takes place automatically.

You can change the water temperature set by tapping the DOWN arrow key. In this way this part of the display is highlighted and the currently set temperature is shown. With the UP and DOWN arrow keys it is possible to modify this value. The confirmation of each change takes place automatically within 3 seconds of the change or by pressing the confirmation button. An acoustic signal certifies the change.

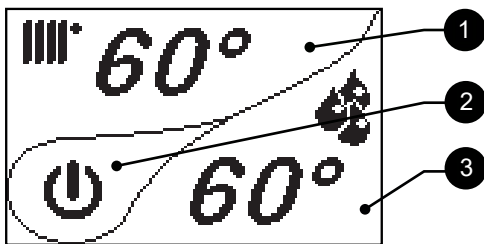
Diagram 2 (buffer tank sensor)

1. Indicates the water temperature of the storage puffer that you want to reach (if the thermostat is connected to the puffer, it indicates whether it requires heating the domestic water with ON t.ext. Or not with OFF t.ext.);
2. Icon indicating the status of the stove;
3. Indicates the temperature of the water in the thermo stove.

It is possible to change the puffer water temperature set by touching the UP arrow key. In this way this part of the display is highlighted and the currently set temperature is shown. With the UP and DOWN arrow keys it is possible to modify this value. The confirmation of each change takes place automatically within 3 seconds of the change or by pressing the confirmation button. An acoustic signal certifies the change.

It is not possible to change the water temperature in the thermo stove.

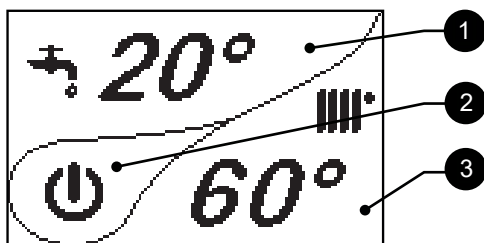
Diagram 3 (boiler sensor + buffer tank sensor)

1. Indicates the temperature of the DHW tank to be maintained (if the thermostat is connected to the tank, it indicates whether it requires heating the domestic water with ON t.ext. or not with OFF t.ext.);
2. Icon indicating the status of the stove;
3. Indicates the water temperature of the storage puffer that you want to reach (if the thermostat is connected to the puffer, it indicates whether it requires heating the domestic water with ON t.ext. Or not with OFF t.ext.)

It is possible to change the DHW temperature set by touching the UP arrow key. In this way this part of the display is highlighted and the currently set temperature is shown. With the UP and DOWN arrow keys it is possible to modify this value. The confirmation of each change takes place automatically within 3 seconds of the change or by pressing the confirmation button. An acoustic signal certifies the change.

It is possible to change the puffer water temperature set by touching the DOWN arrow key. In this way this part of the display is highlighted and the currently set temperature is shown. With the UP and DOWN arrow keys it is possible to modify this value. The confirmation of each change takes place automatically within 3 seconds of the change or by pressing the confirmation button. An acoustic signal certifies the change.

Quick status display

From the Home screen, by touching the CONFIRM key it is possible to view some parameters measured by the stove control unit. The displayed parameters changes according to the set pattern.

POTENZA	MOD	POTENZA	MOD
POMPA	ON	POMPA	ON
VAL. 3 VIE	RISC	VAL. 3 VIE	RISC
PRESSIONE	1.1 bar	PRESSIONE	1.1 bar
		T.PALM	21 °C

- POWER: indicates the power of the stove, which can be:
 - MIN: operation at minimum power;
 - MAX: operation at maximum power;
 - MOD: modulation of the stove with settings reached;
 - SANI: if the rapid DHW kit is present, as soon as there is a request for domestic hot water, the stove switches to domestic power autonomously;
- PUMP: indicates whether the pump is on or off;
- 3-WAY VALVE: indicates whether the three-way valve is in the HEATING, SANITARY, PUFFER or BOILER position;
- PRESSURE: indicates the water pressure in the stove.
- REMOTE CTRL TEMPERATURE: temperature detected by the handheld remote control

OPERATING PHASES OF THE APPLIANCE

Sequence of ignition phases

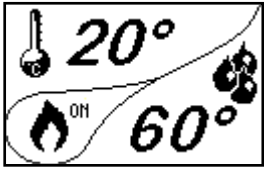

SWITCH-ON - initial pellet loading phase;

WAIT FLAME - flame development wait phase;;

FLAME PRESENT - flame stabilization phase and reduction of combustible inside the brazier;

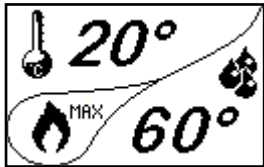

WORK - operation phase described in the dedicated chapter;

Modulation

During the work phase, the appliance should reach the room temperature set; when this condition is met, the stove switches to MODULATION mode in which fuel consumption is minimum.

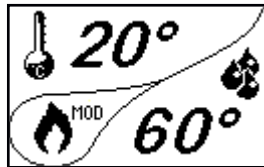

When the set room temperature is reached, the stove goes into Modula mode and the pump switches off. In the event of an increase in the water temperature, the pump is automatically reactivated.

Eco stop

With the "COMFORT CLIMA" function activated, the stove switches off when the room / water temperature set has been reached. With the "Summer" season set, the stove switches off when the DHW (boiler) temperature has been reached.

Stand-by

The STAND-BY mode is activated when the temperature of the water reaches 85°C, this function is aimed at protecting the circuit especially when COMFORT CLIMATE function is not active on boiler H2O. If the boiler is not in this condition, it switches to STAND-BY mode to guarantee protection of the hydraulic circuit. The boiler restarts automatically after it cooled down, on the condition that heating is requested.

Sanitary

If there is an external rapid exchanger with flow switch, when the domestic water is opened the stove goes to "Sanitary" power. This function is enabled only with scheme 0. If the stove is off, it remains off.

Description of menu functions

To access the MENU screen, press the menu access button



To scroll the menu list, use the "UP" and "DOWN" buttons and then press the confirmation key to enter the submenus. Then, to return to the "Home" screen, press the return button several times.

The stove is equipped with many functions available in each menu programming. Some of these menu are accessible for the end user, other are protected with a password so they are accessible only for the After sales center.

MENU
USER
TECHNICIAN
PRODUCER

Menu USER
Menu TECHNICIAN
Menu PRODUCER



The TECHNICAL and PRODUCER menus are password protected. Changing parameters within these menus could compromise the operation and safety of the stove. In this case the warranty will be invalidated.

The submenus of the USER MENU (the only one accessible for the end user) are the following:

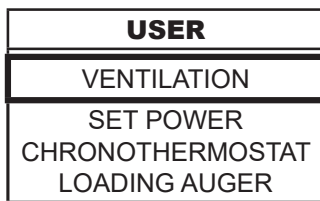

Menu VENTILATION
Menu SET POWER
Menu CHRONOTHERMOSTAT
Menu LOADING AUGER

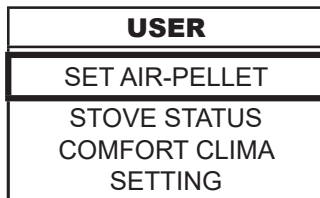

Menu SET AIR-PELLET
Menu STOVE STATUS
Menu COMFORT CLIMA
Menu SETTING

Ventilation

The stoves that have ventilation have the ability to heat the environment also thanks to the ventilation.



The temperature read by the handheld unit controls the modulation of the stove. If you want to adjust the ventilation by adjusting the stove, set the fan to A mode as shown in the relative chapter.

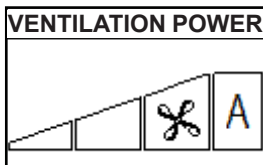

Press the increase/decrease keys "increase/decrease" to change the ventilation.

Ventilation can be set from 0 (OFF) to 3 (maximum value). If you set value A (automatic), the ventilation follows the set power of the stove.



In some models, changing the fan speed may be limited. See the paragraph "Description of operation".

Set power

These stoves have been designed to automatically adjust the power according to the thermal demand. However, you can choose to run it at minimum power using this function.

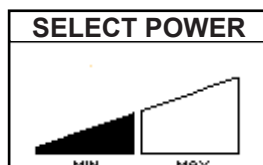

Using the "UP" and "DOWN" keys it is possible to modify the working power



The power selection is effective only in the working state of the thermo-stove. At each restart, the value is automatically reset to MAX.

Chronothermostat

With the Chronothermostat function you can program the automatic switch ON/OFF of the stove in 4 independent time intervals (SET CHRONO 1-2-3-4).

To enable the function, access the CHRONOTHERMOSTAT menu and then the ACTIVATE CHRONO function

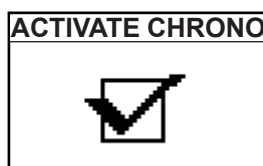
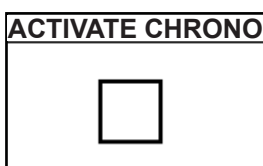

To modify one of the 4 available programs, select the CRONO program to be modified and enter the modification screen.

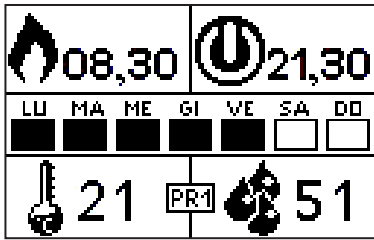

By pressing the Increment key you can change each value and enable the days of the week;



By pressing the Decrement key you can change each value and enable the days of the week;



Press "confirm" to confirm the settings and switch to the next value;



Press the "back" button to return to the CHRONOTHERMOSTAT page.

Examples

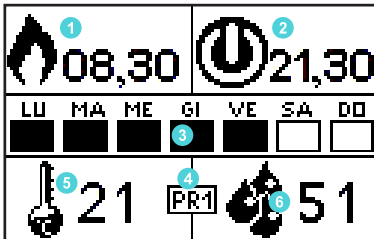

- 1: Switch on at 8.30
- 2: Switch off at 21.30
- 3: Activation days: Monday to Friday
- 4: Program number "chrono": 1
- 5: Room temperature set at 21°C
- 6: Water temperature set at 51°C

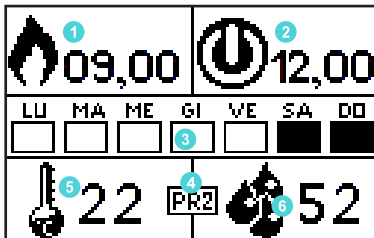

- 1: Switch on at 9.00
- 2: Switch off at ore 12.00
- 3: Activation days: Saturday and Sunday
- 4: Program number "chrono": 2
- 5: room temperature set at 22°C
- 6: Water temperature set at 52°C

In models with ventilation, it is possible for each programming to manage the ventilation speed as specified above.

Set air - pellet

The setting of the PELLET - FLOW mixture allows to adjust the combustion by varying the quantity of pellets loaded in the brazier and/or the quantity of air. In fact, by its nature, pellets vary in grain size and composition: even bags of pellets of the same brand can have different characteristics.

If combustion is not optimal, vary the flow parameter to adjust the combustion air. If air regulation alone is not sufficient, it may also be necessary to modify the pellet parameter.



Combustion regulation is an operation that requires a lot of experience. We recommend that you contact an Authorised Service Centre to calibrate the stove appropriately.

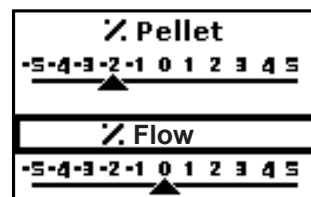
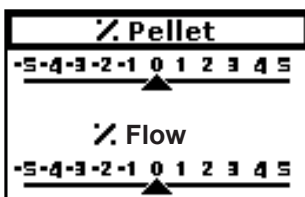

Use the UP and DOWN buttons to change the pellet % value.

Press the CONFIRM button to confirm the value and change to the item % flow.

Stove status

In this menu, you can check the correct operation of the most important parameters of the appliance. Below is a list of real stove data useful for the assistance service during the control phases.

ACTIVE COMPONENTS

- PUMP: circulator state (ON running)
- 3-WAY VALVE: position of 3-way valve DHW (domestic hot water) or HEAT (heating);
- PRESSURE: system pressure;
- Stove status;

REAL STATUS

- POWER: current boiler power;
- RDS: flow read by the flow meter;
- RPM: fume extractor speed;
- SET: actual flow set (Air-flow meter);

TEMPERATURES

- REMOTE CTRL TEMPERATURE: Temperature read by the handheld unit;
- T.EXT: External thermostat (request ON);
- T.FLAME: Flame temperature (combustion chamber);
- T.SMOKE: Combustion fume exhaust temperature;
- T.DEB.C: Inlet flow meter temperature;
- T.DEB.H: Heated flow meter temperature;
- T.MB: Electronic board temperature;

TEMPERATURE H2O

- T.H2O O: Boiler water temperature (SUPPLY);
- T.H2O I: Boiler water temperature - RETURN from the system;
- WATER HEATER T.: Boiler DHW temperature;
- T.PUFFER H: Puffer temperature - average warm point;
- T.PUFFER L: Puffer temperature second reading (low temperature).

Comfort clima

Activating this function allows the stove to turn off automatically, once the desired room temperature has been reached. When the room temperature reaches the value set on the palmtop or on the external thermostat, the stove activates the modulation phase. If the temperature reached is maintained for a set period of time (DELAY SWITCH OFF), the stove switches off automatically, and the message ECO appears on the display. The stove re-ignites when the temperature drops below the set threshold (DELTA RESTART).

Once you have accessed the climate comfort menu, you can operate on the settings dedicated to the function:

ACTIVATE COMFORT: to enable / disable the function

COMFORT MANAGEMENT: to choose whether to enable the climate comfort function based on the water or room temperature

DELTA RESTART: to modify the Delta Comfort climate value

DELAY SWITCH OFF: to modify the Delay Switch Off value

The COMFORT CLIMA function has the purpose of activating the ECO STOP status if the set temperature of the room / boiler water is kept at the set value for at least "X" minutes (DELAY SWITCH OFF). The stove maintains this state until the room / water temperature drops below the "Y" value (Y = Set value - DELTA COMFORT CLIMA).

For example, with the Climate Comfort "Air" management, an environment set of 21 ° C, Delta Comfort Clima "5 ° C", Delay Switch Off "5 min", the stove goes into Modula power when it reaches 21 ° C and if the temperature is maintained for 5 minutes, the stove switches off (Eco stop). The stove restarts when a temperature of 16 ° C (21 ° C - 5 ° C) is detected.

For example, with a boiler water set of 65 ° C, the stove switches off when it is reached, to restart when a temperature of 60 ° (65 ° C - 5 ° C) is detected.



<input type="checkbox"/> AIR <input checked="" type="checkbox"/> H20		Select the type of Comfort Clima management on the water temperature or on the room temperature using the UP or DOWN arrow keys	
DELTA COMFORT CLIMA 0 °C		DELTA COMFORT CLIMA 5 °C	
DELAY SWITCH OFF 0 min		DELAY SWITCH OFF 5 min	

Setting

Within the SETTINGS menu there are various functions:

- DATE - HOUR
- ENABLE T.EXT
- SEASON
- CONTRAST
- VERSION FW
- LANGUAGE
- ADJUST

Setting > Date - hour

Access the SETTINGS menu and then the DATE-TIME menu

hh mm Day 19:20 - MA gg mm aa 20 / 10 / 13		Press the increase key to change every single value
		Press the decrease key to change every single value
		Press "confirm" to confirm the settings and switch to the next option.
		Press the "back" button to return to the SETTING page

The function can also be activated using an external thermostat, in this case the DELTA COMFORT CLIMA value is not considered.

Setting > Enable t.ext

With this function it is possible to activate the use of an external thermostat by pressing the "confirm" button to enable or disable the function.

ACTIVATE T.EXT <input type="checkbox"/>		ACTIVATE T.EXT <input checked="" type="checkbox"/>	
--	--	---	--



In "Home" mode, instead of room temperature measured and settable, appears the line T ON if the room in which the thermostat is installed has not reached the temperature requested or the writing T OFF if the temperature in the room is reached.

Setting > Season

With this function it is possible to choose the WINTER or SUMMER season. In summer mode the stove works only to heat the DHW.



Use the UP/DOWN keys to change the WINTER/SUMMER season.

Setting > Contrast

With this function you can change the contrast setting to improve the display of your handheld. The contrast setting to improve the display of the handheld display.

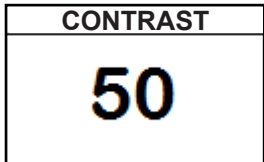

Use the UP/DOWN keys to change contrast setting and obtain a better visualisation of the information shown on the handheld set.

The value can vary from 0 to 100. 50 with respect to the standard value.

Setting > Version firmware

With this function you can view the current firmware version.

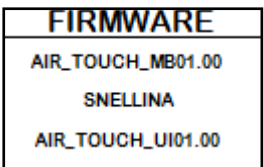
Setting > Language

To access the next setting, follow the steps given above or simply remove and replace the batteries. The device resets and prompts you again to select the language you want to set.

Setting > Adjust

The adjust function allows you to change the value read by the ambient probe inside the palmtop, increasing or decreasing it by the set value (offset).



Make this adjustment carefully and only after having checked deviations from the actual room temperature with a reliable instrument!

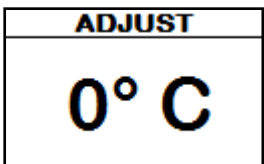

With the "UP" and "DOWN" keys it is possible to make a change to the value read by the ambient probe inside the handheld with respect to a reference value.

The value can vary from -10°C to 10°C. The standard value is 0°C.



Anti-condensation system

The anti-condensation system, if activated, prevents the temperature of the fumes in the flue from dropping too much when the stove is in Modula power.

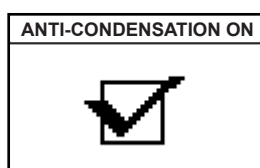
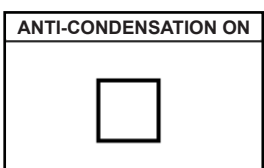
It is possible to activate or deactivate the function by pressing the "confirm" key.

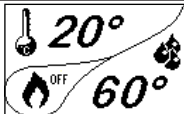

Stove phase general layout

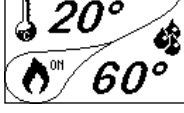
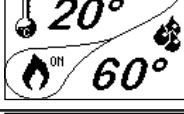
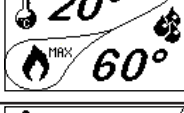
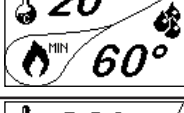
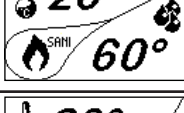
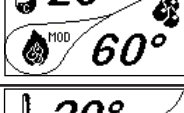
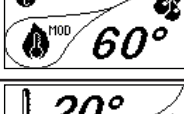
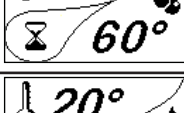
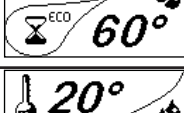
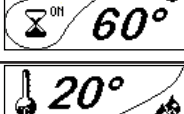
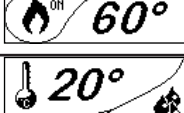
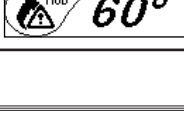
	Phase	Description
	FINAL CLEANING	The stove is in the switch off phase and the cooling phase has not been completed yet.
	SWITCH ON	The heater pre-heating phase has started and the pellets start to fall into the grate.
	WAITING FOR FLAME	The pellets ignite and take advantage of the heat in the intake air that passes through the incandescent heater tube.
	FLAME PHASE	The flame develops in the grate.
	WORK AT MAX P	The stove has completed the switch on phase and runs at maximum set power
	WORK AT MIN P	The stove works at the operating power set after ignition.
	WORK AT DHW P	The stove works at an operating capacity dedicated to DHW (flow switch request with DHW kit or DHW boiler)
	MODULATE H2O	The desired boiler water set temperature has been reached.
	ROOM TEMPERATURE MODULATION	The room temperature set has been reached.
	THE GRATE	Brazier cleaning phase is active (periodic function).
	ECO STOP	With Climate Comfort active, the stove switches to automatic switch-off mode when the room temperature set is reached (see the dedicated section).
	START/RESTART WAIT	Switch-on is requested but with the stove in cooling phase; once this condition is met, it restarts automatically.
	SWITCH ON RESTART	The HOT restart phase is activated. Functioning is similar to the SWITCH ON phase
	HOT SMOKE	The maximum fume temperature threshold has been reached. To facilitate cooling, the stove brings the capacity to a minimum with ventilation at power level 5, leading to a decrease in fume temperature.

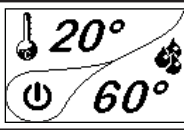
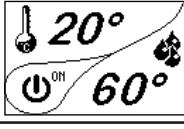
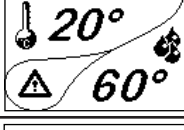
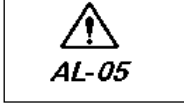
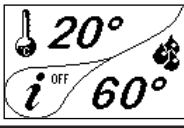
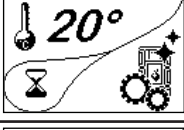
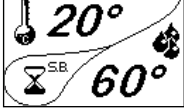
	Phase	Description
	OFF	The stove is off
	WAIT FOR PELLETS OUT OF	When the switch-on request from ECO-STOP mode coincides with an automatic switch-off condition (from the TIMER), the stove turns on ensuring total cleaning of the brazier before switching to FINAL CLEANING.
	AUGER OVERFLOW	CONDITION: when the pellet setting (set pellets +5) is near the continuous load condition. SOLUTION: Set the value back to 0.
	GENERIC ALARM	The stove is in alarm state; refer to the troubleshooting chapter.
	ANOMALY (general)	The stove has detected an anomaly; refer to the troubleshooting chapter. By pressing the confirmation key, the problem is described.
	AUTOMATIC CLEANING SYSTEM ACTIVE	For models with automatic cleaning system it indicates the operating state of the same.
	STAND BY	Forced shutdown state when the boiler water reaches 85°C. The stove restarts automatically if the restart conditions are met.

Warning Pop -Up

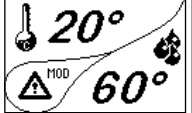
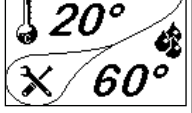
	Anomaly	Description
 ADJUST RDS SYSTEM	RDS SYSTEM REGULATION REQUEST (only if the RDS system is installed)	It shows that the testing procedure and initial parameter calibration have been completed incorrectly. This indication, however, does not block the stove.
	FLOW METER FAILURE (only if the RDS system is installed)	It shows a failure of the air flow meter and the stove switches to minimum capacity disabling the RDS system.
	SERVICE REQUEST	The threshold value of set work hours has been reached. The symbol displayed remains active throughout the work phase. Non-routine maintenance is required on the stove.

Signalling	Reason	Solution
CLEAN THE GRATE (only if the RDS system is installed)	The door and the ash box are not closed correctly	Make sure they are closed properly.
	Poor combustion in grate.	Switch off the stove, clean the brazier and check the cleanliness of the support bench, clean the tube bundle by activating the turbolators and adjust the combustion through pellet/air settings.
	Presence of foreign body in air intake tube.	Check if present and remove foreign body
	The air flow meter may be dirty.	Clean the flow meter with the stove in "Switched off" state
		Contact the Support Service



The appearance of the "SET RDS" message indicates that the initial parameter testing and calibration procedure was not carried out correctly. This indication does not imply blocking the stove.

Alarms (table with reference codes)

Cod.	Title	Reason	Solution
AL 01	BLACK OUT	No voltage during work phase	Press the switch off key and switch on the stove again
			If the problem persists, contact the Support Service
AL 02	FLAME / FLUE GAS PROBE FAILURE	The K probe is malfunctioning	Contact the Support Service
		The K probe is disconnected from the electronic board	Contact the Support Service
AL 03	OVER-TEMPERATURE FLAME / FLUE GAS	Combustion in the brazier is not optimal due to clogging or obstructions of internal stove ducts inside the stove	Switch off the stove, clean the brazier and the tube bundle and adjust the combustion setting the Pellet/Air values
			Contact the Support Service
			If the problem persists, contact the Support Service
AL 04	FUME EXHAUST DAMAGED	Fume exhaust encoder is not working or is connected incorrectly	Contact the Support Service
		No power to fume extractor.	Contact the Support Service
		The fume extractor is blocked.	Contact the Support Service
AL 05	NO SWITCH-ON	The pellet tank is empty.	Check for the presence of pellets in the container. Top up, if necessary.
		Pellet calibration and suction during switch on phase is incorrect.	Contact the Support Service
		The ignition coil is faulty or positioned incorrectly	Contact the Support Service
AL 06	PELLETS FINISHED	The pellet tank is empty.	Check for the presence of pellets in the container. Top up, if necessary.
		The gear motor is not loading pellets.	Empty the tank to see if there are any objects inside that may prevent proper operation of the auger.
		Not enough pellets loaded	Regulate pellets setting from "SET AIR/PELLETS"
			If the problem persists, contact the Support Service
AL 07	RESETTABLE THERMAL BREAKER	The manual reset thermostat connected to the hopper has been triggered	Reset the thermostat by pressing the button on the back of the stove
		Combustion in the brazier is not optimal due to clogging or obstructions of internal stove ducts inside the stove	Switch off the stove, clean the brazier and the tube bundle and adjust the combustion setting the Pellet/Air values
			Contact the Support Service
AL 08	DEPRESSION	The flue is blocked.	Check the flue is free and clean
		The vacuum meter is faulty.	Contact the Support Service
AL 10	OVERTEMP. H2O	The boiler water temperature exceeds 90 °C.	Contact the Support Service
AL 11	H2O PROBE FAILURE	The boiler water probe is malfunctioning.	Contact the Support Service
		The boiler water probe is disconnected from the electronic board.	Contact the Support Service

Cod.	Title	Reason	Solution
AL 12	FUME EXHAUST SYSTEM	The fume exhaust system has a loss of performance due to fan obstruction or voltage drop.	Contact the Support Service
AL 14	AUGER PHASE	No cable connection to power the gear motor	Contact the Support Service
AL 15	AUGER TRIAC	An internal part of the electronic board that controls the pellet auger is faulty.	Contact the Support Service
		Possible voltage drops or incorrect input voltage	Check the mains voltage.
AL 16	PRESSURE	The pressure of the system is greater or lower than a preset value, allowed values from bar to 2.5 bar. (We recommend at cold circuit a pressure of about 1.0 bar)	Fill the system or vent it to bring the pressure to the value requested for correct operation.
			If the problem persists, contact the Support Service
AL 17	NO FLOW (only if the RDS system is installed)	The flow meter does not measure an input air flow	Check whether the door and the drawer are properly closed, correctly and check if the air inlet pipe is obstructed.
			If the problem persists, contact the Support Service
AL 19	CLEANER FAILURE	The cleaner did not complete the movement and is not in the correct position	Reset the alarm and wait for the stove to switch to SHUTDOWN mode. Cut off and power again, the system reactivates the cleaner searching the correct position again.
			If the problem persists, contact the Support Service





Any alarm condition causes the immediate shutdown of the thermo stove. Press the power button to reset the alarm. Before restarting the thermo stove, check that the signal has been resolved and in the models without automatic cleaner the brazier is well cleaned to ensure correct restarting.

MAINTENANCE

Safety warnings for maintenance

 Maintenance of the stove must be performed at least once a year and should be planned in advance with the Technical Assistance Service.

 In some conditions, such as turning the stove on and off or inappropriate use, the combustion products can contain small soot particles that build up in the smoke evacuation system. This can reduce the cross-section of the smoke duct and pose a fire risk. The smoke evacuation system must be inspected and cleaned at least once a year.

 The maintenance operations must be carried out when the stove is cold and with the electrical power supply disconnected.

Before completing any maintenance operation, adopt the following precautions:

- Make sure that the power supply plug is disconnected.
- Make sure that all stove parts are cold.
- Make sure that the ashes are completely cold.
- Always operate with equipment that is appropriate for maintenance.
- When maintenance is finished, re-install all of the dis-assembled parts before restarting operation.

 The quality of the pellet, the stove operating mode and combustion control can affect maintenance activity frequency.

Cleaning

 Perform the cleaning operations so as to guarantee correct stove operation.

The table below lists the necessary cleaning operations required for correct stove operation.

PARTS / FREQUENCY	2-3 DAYS	30 DAYS	60/90 DAYS
Ash drawer		•	
Glass	•		
Turbulators	•		
Combustion chamber		•	
Pellet tank		•	
Extraction duct			•

 In the first periods of use, carry out cleaning operations frequently to understand the right frequency of intervention, which varies according to the installation, use, pellet used, etc.

Cleaning the ash drawer

The ash drawer must be cleaned every 30 days, (depending on the amount of time the stove is used and what type of pellet is used). To clean the ash drawer, proceed as follows:

step	action
1	Remove the ash drawer and empty it.
2	Clean all areas around the ash drawer.

In stoves without ash drawer:

step	action
1	Vacuum the residues present in the ash compartment with a suitable ash vacuum cleaner, making sure that the ashes are completely extinguished.

Glass cleaning

With a cold stove, clean the glass with a cloth and glass cleaner.

Note: there are stove glass cleaning products available on the market.

Cleaning the turbulators

During operation, dust and soot are deposited on the surface of the heat exchanger tubes. To ensure smooth operation throughout the season, it is advisable to periodically clean the heat exchanger when the stove is cold.

step	action
1	Firmly move the turbulators up and down.
2	Once you have finished cleaning the exchanger, never leave the scraper removed.

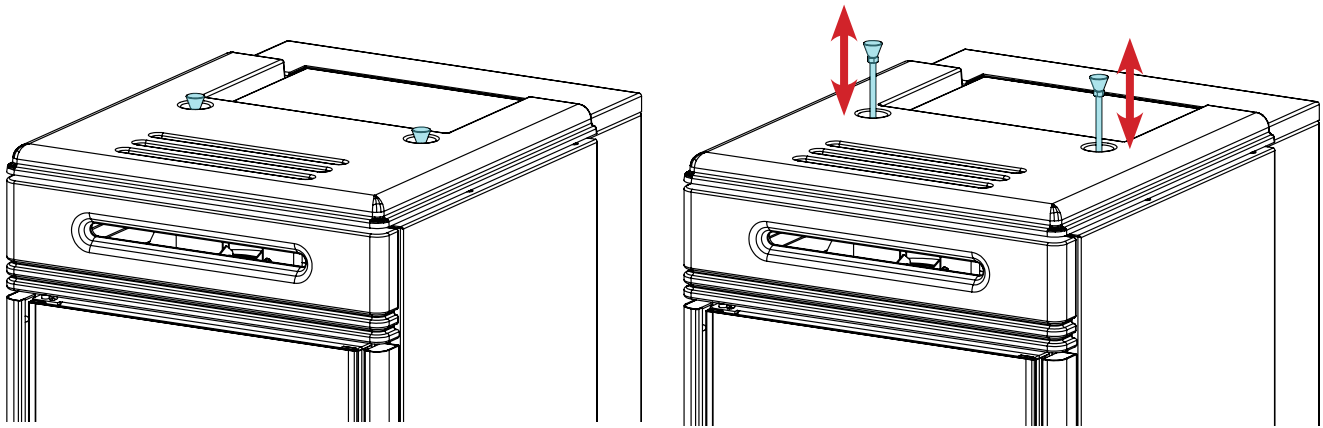

Combustion chamber cleaning

To clean the ash drawer, proceed as follows:

step	action
1	The stove requires a simple yet frequent cleaning in order to guarantee suitable yield and regular operation. Vacuum the combustion chamber every day using a bin ash vacuum, making sure that the ashes are completely cold.

Cleaning the pellet tank

To clean the pellet tank, proceed as follows:

step	action
1	Periodically remove the wood sawdust accumulated on the bottom of the tank, using a vacuum cleaner.

Extraction duct cleaning

Periodically check that the extraction duct is free from obstructions (dust, animal hair ...) and remove them if necessary.



In stoves with RDS technology, it is necessary to be extremely careful not to break the air flow sensor.

Extraordinary maintenance



Extraordinary maintenance activities must be carried out by staff from the Authorised Assistance Centre.



Do not wait for components to be deteriorated by use before proceeding with their replacement. Replace a worn component before it is completely broken to prevent any damage caused by sudden component breakage.

PARTS/FREQUENCY	1 SEASON
Deep combustion chamber cleaning	•
Door gasket	•
Chimney	•
Smoke conduit	•



Schedule the above extraordinary maintenance activities with the Authorised Assistance Centre.

Failure cases

Problem	Causes	Possible remedies	Alarm signal
No pellets are loaded into the combustion chamber	The pellet tank is empty	Load the pellets into the tank	AL 05 AL 06
	The auger is blocked	Empty the tank to check that no objects have fallen inside that prevent the auger from rotating	AL 05 AL 06
	The auger rotates but no pellets are loaded	Check that the pellet feed channel into the combustion chamber is free from obstructions, such as sawdust, stuck pellets or other objects. In this case, free from obstruction, it is advisable to contact the Technical Assistance Service.	AL 05 AL 06
	Faulty gearmotor	Replace the gearmotor (contact the Technical Assistance Service.)	AL 05 AL 06
	Defective electronic board	Replace the electronic board (contact the Technical Assistance Service.)	
	Triac failed	Replace the electronic board (contact the Technical Assistance Service.)	AL 15
The flame does not ignite	Check that the igniter warms up	Check and, if necessary, replace the igniter	AL 05
	Air inlet duct blocked	Check the patency of the air inlet duct	
	Incrustations in the brazier that block the passage of air from the igniter	Verification and removal of incrustations	AL 05
	Pellet loaded in insufficient ignition	It is advisable to contact the Technical Assistance Service to have the initial load adjusted.	AL 05
Excessive gas formation during stove ignition	Excessive load of pellets during ignition	It is advisable to contact the Technical Assistance Service to have the initial load adjusted.	
	Obstructed drain	Clean the smoke duct	
	 In case of excessive gas formation inside the combustion chamber during the ignition phase, it is advisable not to stand in front of the stove and not to approach the combustion chamber glass, but to wait for the flame to ignite in a safe place . For more information see the paragraph "What to do in case of overload during ignition"		

Problem	Causes	Possible remedies	Alarm signal
The flame goes out	The pellet tank is empty.	Load the pellets into the tank	AL 05 AL 06
	Pellet is not loaded	See previous problem	AL 05 AL 06
	The safety reset thermostat has intervened	Check that the water is free to circulate in the stove and in the system, for example by checking the shut-off valves. Let the stove cool down, reset the reset thermostat, reset the alarm and turn the appliance back on; if the problem persists, contact the technical assistance service	AL 07
	Open combustion chamber door and / or ash drawer.	Close the combustion chamber door, the ash drawer or the hopper lid	AL 07
	Water pressure too high or too low	Check the plumbing system	AL 16
	Inadequate pellets	Change the type of pellets with one recommended by the manufacturer	AL 05 AL 06
	Inadequate air / pellet ratio	Adjust the "AIR-PELLET SET" setting: decrease the air set and, if necessary, increase the pellet set	AL 05 AL 06
	Dirty combustion chamber	Clean the combustion chamber following the instructions in the booklet	AL 05 AL 06
	Smoke extraction motor failure	Check and replace the motor if necessary	AL 04
	Obstructed drain	Clean the smoke duct	AL 08
The stove stops automatically	The door is not closed perfectly or the gasket are worn	Close the door and have the gaskets replaced with original ones	AL 05 AL 06
	Alarm presence	Check the alarm table	(Any alarm)
	Active chronothermostat	Check if the chronothermostat is active	
The pellets accumulate in the brazier and the flame is weak	External thermostat enabled	Check the settings of the external thermostat	
	Insufficient combustion air	Make sure that the air intake in the room is present and free	
	The door is not closed perfectly or the gasket are worn	Close the door and have the gaskets replaced with original ones	
	Smoke duct blocked	Clean the smoke duct	
	Inadequate air / pellet ratio	Adjust the "AIR-PELLET SET" setting: decrease the air set and, if necessary, increase the pellet set	
	Wet or inadequate pellets	Change the type of pellets	
The flue gas fan does not work	Smoke extraction motor faulty	Check and replace the motor if necessary	AL 04
	The engine is broken	Check the motor, the capacitor, and the wiring and replace them if necessary	AL 04
The air fan never stops	The card is defective	Replace the electronic board	
	Fume probe faulty or broken	Check the operation of the probe and replace it if necessary	
The air fan does not turn on	Defective electronic board	Replace the electronic board	
	The appliance has not reached the threshold temperature	Please wait	
	The air fan is broken	Replace the fan	

Problem	Causes	Possible remedies	Alarm signal
No communication between the stove and the remote control	Remote control not associated with the stove	Pair the remote control to the stove following the instructions given here	
	Radio interference	Evaluate the presence of other radio devices in the vicinity	
	Remote control firmware not compatible with stove firmware ("LINK" message appears on the display)	Contact the technical assistance service to update the remote control FIRMWARE	
	Communication component of the card or remote control faulty	Replace electronic card or remote control	
The remote control does not work	Remote control battery low	Replace battery or connection to the stove via cable	
	Faulty remote control	Replace remote control	
The stove always works at maximum power	Temperature not set correctly	Set the remote control temperature again	
	Remote control position not optimal for detecting room temperature	Place the remote control in another location	
	Additional temperature probe or external thermostat (if present) faulty	Check probe or thermostat and replace if necessary	
	Defective or broken remote control	Check the remote control and replace if necessary	
The stove does not turn on	Lack of electricity	Check that the power plug is inserted and the switch in the "I / ON" position.	
	Fuse tripped following a fault	Replace the fuse with one having the same characteristics (5x20 mm T 3.15A)	
	Clogged exhaust or smoke duct.	Clean the smoke outlet and / or the smoke duct	

STORAGE AND DISPOSAL

Disposal

Demolition and disposal of the stove is under the exclusive liability and responsibility of the owner who must do so in accordance with the laws in force in the country of installation pertaining to safety, respect and protection of the environment.

At the end of its service life, the product must not be disposed of as household waste. It can be taken to designated separate waste collection centres run by local administrations or to dealers who offer this service.

Disposing of the product as sorted waste avoids any negative consequences on the environment and health deriving from unsuitable disposal and it recovers the materials that the stove is composed of in order to save considerable energy and resources.

TROUBLESHOOTING

The stove does not work

- closely follow the directions in the dedicated chapter of this manual.
- make sure that the air intake duct is not obstructed;
- make sure that the smoke evacuation system is clean and not obstructed;
- make sure the chimney is sized for the stove power;
- make sure that the air intake in the room is clear of any obstructions and that there are no other combustion appliances or extraction hoods that create a vacuum in the room;

Difficult lighting

- closely follow the directions in the dedicated chapter of this manual;
- make sure that the air intake duct is not obstructed;
- make sure that the smoke evacuation system is clean and not obstructed;
- make sure the chimney is sized for the stove power.
- make sure that the air intake in the room is clear of any obstructions and that there are no other combustion appliances or extraction hoods creating a vacuum in the room.

Smoke leakage

- Check the draught of the chimney.
- Check whether the seals on the door, drawer and smoke evacuation system are intact.
- Make sure there is no ash obstructing the primary air flow grille.

The glass gets dirty easily

- Only use recommended fuels.
- Check the draught of the chimney.

Downtime (end of season)

At the end of every season we recommend vacuuming out any ash and dust that may still be inside. It is advisable to let the pellets burn out in the tank so that the pellet remains and sawdust can be vacuumed from the bottom and from the screw.

Disconnect the stove from the power supply.

With thermo-stove or boiler, it is not necessary to empty it of water, but it is advisable to close the shut-off valves at the inlet and outlet for prolonged downtime.

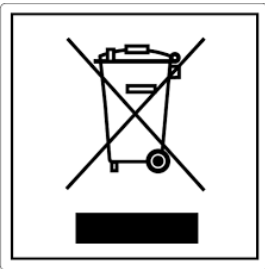

ITA-Informationi per la gestione di rifiuti di apparecchiature elettriche ed elettroniche contenenti pile e accumulatori

Questo simbolo che appare sul prodotto, sulle pile, sugli accumulatori oppure sulla loro confezione o sulla loro documentazione, indica che il prodotto e le pile o gli accumulatori inclusi al termine del ciclo di vita utile non devono essere raccolti, recuperati o smaltiti assieme ai rifiuti domestici.

Una gestione impropria dei rifiuti di apparecchiature elettriche ed elettroniche, di pile o accumulatori può causare il rilascio di sostanze pericolose contenute nei prodotti. Allo scopo di evitare eventuali danni all'ambiente o alla salute, si invita l'utilizzatore a separare questa apparecchiatura, e/o le pile o accumulatori inclusi, da altri tipi di rifiuti e di consegnarla al centro comunale di raccolta. È possibile richiedere al distributore il ritiro del rifiuto di apparecchiatura elettrica ed elettronica alle condizioni e secondo le modalità previste dal D.Lgs. 49/2014.

La raccolta separata e il corretto trattamento delle apparecchiature elettriche ed elettroniche, delle pile e degli accumulatori favoriscono la conservazione delle risorse naturali, il rispetto dell'ambiente e assicurano la tutela

della salute.

Per ulteriori informazioni sui centri di raccolta dei rifiuti di apparecchiature elettriche ed elettroniche, di pile e accumulatori è necessario rivolgersi alle Autorità pubbliche competenti al rilascio delle autorizzazioni.

ENG-Information for management of electric and electronic appliance waste containing batteries or accumulators

This symbol, which is used on the product, batteries, accumulators or on the packaging or documents, means that at the end of its useful life, this product, the batteries and the accumulators included must not be collected, recycled or disposed of together with domestic waste.

Improper management of electric or electronic waste or batteries or accumulators can lead to the leakage of hazardous substances contained in the product. For the purpose of preventing damage to health or the environment, users are kindly asked to separate this equipment and/or batteries or accumulators included from other types of waste and to arrange for disposal by the municipal waste service. It is possible to ask your local dealer to collect the waste electric or electronic appliance under the conditions and following the methods provided by national laws transposing the Directive 2012/19/EU.

Separate waste collection and recycling of unused electric and electronic equipment, batteries and accumulators helps to save natural resources and to guarantee that this waste is processed in a manner that is safe for health and the environment.

For more information about how to collect electric and electronic equipment and appliances, batteries and accumulators, please contact your local Council or Public Authority competent to issue the relevant permits.

FRA-Informations relatives à la gestion des déchets d'appareils électriques et électroniques contenant des piles et des accumulateurs

Ce symbole présent sur le produit, sur les piles, sur les accumulateurs, sur l'emballage ou sur la documentation de référence, indique que le produit et les piles ou les accumulateurs ne doivent pas être collectés, récupérés ou éliminés avec les déchets domestiques au terme de leur vie utile.

Une gestion improprie des déchets d'équipements électriques et électroniques, des piles ou des accumulateurs peut causer la libération de substances dangereuses contenues dans les produits. Pour éviter d'éventuelles atteintes à l'environnement ou à la santé, on invite l'utilisateur à séparer cet appareil, et / ou les piles ou les accumulateurs, des autres types de déchets et de le confier au service municipal de collecte. On peut demander au distributeur de prélever le déchet d'appareil électrique ou électronique aux conditions et suivant les modalités prévues par les normes nationales de transposition de la Directive 2012/19/UE.

La collecte sélective et le traitement correct des appareils électriques et électroniques, des piles et des accumulateurs, favorisent la conservation des ressources naturelles, le respect de l'environnement et assurent la protection de la santé.

Pour tout renseignement complémentaire sur les modalités de collecte des déchets d'appareils électriques et électroniques, des piles et des accumulateurs, il faut s'adresser aux Communes ou aux Autorités publiques compétentes pour la délivrance des autorisations.

NLD-Informatie voor het beheer van afgedankte elektrische en elektronische apparatuur die batterijen en accu's bevat

Dit symbool, dat op het product, op batterijen, op accu's, op de verpakking of in de documentatie ervan staat, geeft aan dat het product en de batterijen of accu's aan het einde van de gebruiksduur niet samen met het huishoudelijke afval mogen worden ingezameld of verwijderd.

Een onjuist beheer van afgedankte elektrische en elektronische apparatuur, batterijen of accu's kan leiden tot het vrijkomen van gevaarlijke stoffen in de producten. Om schade aan het milieu of aan de gezondheid te voorkomen, wordt de gebruiker aangemoedigd om deze apparatuur en/of de meegeleverde batterijen of accu's van andere soorten afval te scheiden en af te leveren aan de gemeentelijke ophaaldienst. Het is mogelijk om de distributeur te vragen om de afvalinzameling van elektrische en elektronische apparatuur uit te voeren volgens de voorwaarden en de voorschriften die zijn vastgelegd in de nationale bepalingen ter uitvoering van Richtlijn 2012/19/EU.

De gescheiden inzameling en correcte behandeling van elektrische en elektronische apparatuur, batterijen en accu's bevorderen het behoud van natuurlijke hulpbronnen, respect voor het milieu en zorgen voor de bescherming van de gezondheid.

Voor meer informatie over de inzameling van afgedankte elektrische en elektronische apparatuur, batterijen en accu's is het noodzakelijk om contact op te nemen met de gemeenten of de bevoegde overheidsinstanties.

DEU-Informationen für die Entsorgung von elektrischen und elektronischen Altgeräten, die Batterien und Akkus enthalten

Dieses Symbol auf dem Produkt, auf den Batterien, auf den Akkus, auf deren Verpackung oder in deren Unterlagen weist darauf hin, dass das Produkt und die Batterien oder Akkus am Ende ihrer Lebensdauer nicht zusammen mit dem normalen Hausmüll gesammelt, verwertet oder entsorgt werden dürfen.

Eine unsachgemäße Entsorgung von elektrischen und elektronischen Altgeräten, sowie von Batterien oder Akkus kann zur Freisetzung gefährlicher Stoffe im Produkt führen. Um mögliche Umwelt- oder Gesundheitsschäden zu vermeiden, wird der Benutzer aufgefordert, dieses Gerät bzw. die Batterien oder Akkus von anderen Abfallarten zu trennen und der kommunalen Sammelstelle zu übergeben. Außerdem ist es möglich, den Händler um die Rücknahme der elektrischen und elektronischen Altgeräte unter den in den nationalen Vorschriften zur Umsetzung der Richtlinie 2012/19/EU vorgesehenen Bedingungen zu bitten.

Die getrennte Sammlung und die ordnungsgemäße Verwertung von elektrischen und elektronischen Altgeräten, Batterien und Akkus fördert die Erhaltung der natürlichen Ressourcen, respektiert die Umwelt und gewährleistet den Schutz der Gesundheit.

Für weitere Informationen zur Sammlung von elektrischen und elektronischen Altgeräten, Batterien und Akkus wenden Sie sich bitte an die für die Erteilung von Genehmigungen zuständigen Kommunen oder Behörden.

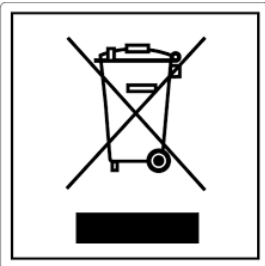

ESP-Información para la gestión de residuos de aparatos eléctricos y electrónicos con pilas y acumuladores

Este símbolo que aparece en el producto, en las pilas, los acumuladores o en su embalaje o su documentación indica que el producto y las pilas o acumuladores que contiene, al final de su vida útil, no deben recogerse, recuperarse o desecharse junto con los residuos domésticos.

Una gestión inadecuada de los residuos de aparatos eléctricos y electrónicos, pilas o acumuladores podría provocar la liberación de sustancias peligrosas contenidas en los productos. Para evitar posibles daños para el medio ambiente o la salud, se recomienda al usuario que separe este aparato y/o las pilas o acumuladores que contiene de otros tipos de residuos y lo entregue al servicio municipal encargado de la recogida. Se puede solicitar al distribuidor la recogida de los residuos de aparatos eléctricos y electrónicos en las condiciones y de acuerdo con las modalidades establecidas por las normas nacionales de transposición de la Directiva 2012/19/UE.

La recogida diferenciada y el tratamiento correcto de los aparatos eléctricos y electrónicos, de las pilas y los acumuladores favorecen la conservación de los recursos naturales, el respeto del medio ambiente y garantizan la protección de la salud.

Para obtener más información sobre las modalidades de recogida de los residuos de aparatos eléctricos y electrónicos, de las pilas y los acumuladores es necesario acudir a los ayuntamientos o las autoridades públicas competentes para la concesión de autorizaciones.

PRT-Informações sobre a gestão dos resíduos de equipamentos elétricos e eletrônicos contendo pilhas e acumuladores

Este símbolo no produto, pilhas, acumuladores ou respetiva embalagem ou documentação indica que, no final do seu ciclo de vida útil, o produto e os acumuladores incluídos não devem ser recolhidos, recuperados nem eliminados conjuntamente com o lixo doméstico.

Uma gestão imprópria dos resíduos de equipamentos elétricos e eletrônicos, pilhas ou acumuladores pode causar a libertação de substâncias perigosas contidas nos produtos. A fim de evitar eventuais danos para o ambiente ou para a saúde, o utilizador é convidado a separar este equipamento e/ou pilhas ou acumuladores incluídos de outros tipos de resíduos e a depositá-los no serviço municipal de recolha de lixo. É possível requisitar a recolha dos resíduos de equipamentos elétricos e eletrônicos pelo distribuidor segundo as condições e modalidades previstas pelas normas nacionais de transposição da diretiva 2012/19/UE.

A recolha separada e o correto tratamento dos equipamentos elétricos e eletrônicos e respetivas pilhas e acumuladores favorecem a conservação dos recursos naturais, o respeito do ambiente e a proteção da saúde.

Para mais informações sobre as modalidades de recolha dos resíduos de equipamentos elétricos e eletrônicos, pilhas e acumuladores, dirija-se à sua Câmara Municipal ou à autoridade pública competente para a emissão das autorizações.

GRC-Πληροφορίες για τη διαχείριση αποβλήτων ηλεκτρικού και ηλεκτρονικού εξοπλισμού, μπαταριών και συσσωρευτών

Αυτό το σύμβολο που εμφανίζεται στο προϊόν, στις μπαταρίες, στους συσσωρευτές στη συσκευασία ή στα έγγραφα υποδεικνύει ότι το προϊόν στο τέλος της ωφέλιμης ζωής του δεν πρέπει να συλλέγεται, να ανασύρεται ή να απορρίπτεται με τα οικιακά απορρίμματα.

Ο ακατάλληλος χειρισμός των αποβλήτων ηλεκτρικού και ηλεκτρονικού εξοπλισμού, μπαταριών ή συσσωρευτών μπορεί να οδηγήσει στην απελευθέρωση επικίνδυνων ουσιών που περιέχονται στο προϊόν. Προκειμένου να αποφευχθεί τυχόν μόλυνση στο περιβάλλον ή ασθένεια, ο χρήστης ενθαρρύνεται να διαχωρίσει αυτόν τον εξοπλισμό ή/και τις μπαταρίες ή τους συσσωρευτές που περιλαμβάνονται από άλλα είδη αποβλήτων και να το παραδώσει στην υπηρεσία δημοτικών συλλογών. Είναι δυνατόν να ζητηθεί από τον διανομέα η συλλογή αποβλήτων ηλεκτρικού και ηλεκτρονικού εξοπλισμού που πρέπει να πραγματοποιηθεί σύμφωνα με τους όρους και με τις διαδικασίες που θεσπίζονται από τις εθνικές διατάξεις εφαρμογής της οδηγίας 2012/19/ΕΕ.

Η χωριστή συλλογή και η σωστή επεξεργασία ηλεκτρικού και ηλεκτρονικού εξοπλισμού, μπαταριών και συσσωρευτών ευνοούν τη διατήρηση των φυσικών πόρων, τον σεβασμό για το περιβάλλον και την προστασία της υγείας.

Για περισσότερες πληροφορίες σχετικά με τον τρόπο συλλογής των αποβλήτων ηλεκτρικού και ηλεκτρονικού εξοπλισμού, μπαταριών και συσσωρευτών είναι απαραίτητο να επικοινωνήσετε με τους δήμους ή τις δημόσιες αρχές που είναι αρμόδιες για την έκδοση των αδειών.

DNK-Informationer til behandling af affald fra elektriske og elektroniske udstyr der indeholder batterier og akkumulatorer

Dette symbol, der vises på produktet, på batterierne eller på akkumulatorerne, på indpakningen eller i dokumentationen, angiver at selve produkt, når dets levetid er opbrugt, ikke skal opsamles, genvindes eller bortskaffes sammen med normalt husholdningsaffald.

En ukorrekt behandling af affald fra elektriske eller elektroniske udstyr, af batterier og akkumulatorer, risikerer at udlede farlige stoffer indeholdt i produktet. For at forebygge ventuelle skader for miljøet eller sundheden, bedes brugeren om at behandle dette udstyr, og/eller de medfølgende batterier eller akkumulatorerne separat fra andre affaldstyper, og at levere det til det kommunale opsamlingscenter, eller at anmode leverandøren om opsamling, i henhold til forskrifterne, der er angivet i de nationale forordninger til gennemførelse af Direktivet 2012/19/EF.

Den separate opsamling og genvinding af de nedslidte elektriske og elektroniske udstyr, af batterierne og af akkumulatorerne, fremmer bevarelsen af de naturlige ressourcer, og sikrer at dette affald behandles ved at tage hensyn til miljøets og sundhedens varetagelse.

Til yderligere informationer angående opsamling af affald fra elektriske og elektroniske udstyr, af batterier og akkumulatorer, er det nødvendigt at rette henvendelse til Kommunerne eller til de ansvarlige myndigheder til udstedelse af bemyndigelserne.

POL-Informacje dotyczące zarządzania odpadami sprzętu elektrycznego i elektronicznego zawierającego baterie i akumulatory

Niniejszy symbol znajdujący się na produkcie, bateriach, akumulatorach, na ich opakowaniu lub na dokumentacji, wskazuje, że produkt, baterie lub akumulatory po zakończeniu okresu użytkowania nie mogą być zbierane, odzyskiwane lub utylizowane wraz z odpadami komunalnymi.

Niewłaściwe postępowanie ze użytym sprzętem elektrycznym i elektronicznym, bateriami lub akumulatorami może powodować uwolnienie niebezpiecznych substancji zawartych w produktach. Celem uniknięcia jakichkolwiek szkód dla środowiska lub zdrowia, użytkownik proszony jest o odseparowanie niniejszego sprzętu i/lub dołączonych baterii lub akumulatorów od innych rodzajów odpadów i dostarczenia go do miejskiego punktu zbierania odpadów. Możliwe jest zwrócenie się z prośbą do dystrybutora o odebranie odpadów sprzętu elektrycznego i elektronicznego, na warunkach i zgodnie z procedurami ustanowionymi przez przepisy krajowe transponujące dyrektywę 2012/19/UE.

Oddzielna zbiórka i prawidłowe przetwarzanie sprzętu elektrycznego i elektronicznego, baterii i akumulatorów sprzyja ochronie zasobów naturalnych, poszanowaniu środowiska i zapewnieniu ochrony zdrowia.

Aby uzyskać więcej informacji dotyczących zbiórki użytego sprzętu elektrycznego i elektronicznego, baterii i akumulatorów, należy skontaktować się z władzami miejskimi lub organami publicznymi odpowiedzialnymi za wydawanie zezwoleń.

SVN-Informacije o ravnanju z odpadno električno in elektronsko opremo, ki vsebuje baterije in akumulatorje

Ta simbol, ki se nahaja na izdelku, baterijah, akumulatorjih ali na njihovi embalaži ali v dokumentaciji, označuje, da se po izteku življenjske dobe izdelka ter baterij ali akumulatorjev, ki jih izdelek vsebuje, ne sme zbirati, predelati ali odstranjevati skupaj z odpadki iz gospodinjstev.

Neprimerno ravnanje z odpadno električno in elektronsko opremo, baterijami ali akumulatorji lahko povzroči izpust nevarnih snovi, ki jih vsebujejo izdelki. Da bi preprečili morebitne škodljive vplive na okolje ali zdravje, uporabnike pozivamo, da tovrstno opremo in/ali baterije ali akumulatorje, ki jih oprema vsebuje, ločujejo od drugih vrst odpadkov ter jih oddajo občinski službi za zbiranje odpadkov. Od distributerja lahko zahtevate prevzem odpadne električne in elektronske opreme pod pogoji in na načine, skladno s katerimi je bila Direktiva 2012/19/EU prenesena v nacionalno zakonodajo.

Ločevanje in ustrezna obdelava električnih in elektronskih naprav, baterij in akumulatorjev pripomoreta k ohranjanju naravnih virov, spoštovanju okolja ter zagotavljanju varovanja zdravja.

Za dodatne informacije o načinih zbiranja odpadne električne in elektronske opreme, baterij in akumulatorjev se obrnite na občine ali na javne organe, ki so pristojni za izdajanje dovoljenj.



Aico S.p.A.

Headquarter

Via Consorzio Agrario, 3 - 25032
Chiari (BS) - Italy

Research and Development Centre

Viale del commercio 12/a - 37135
Verona (VR) - Italy

T. + 39 030 7402939
info@ravelligroup.it

FB Ravellifuocointelligente
IG ravellistufe

www.ravelligroup.it

Aico S.p.A. does not assume any responsibility for any errors in this booklet and considers itself free to make any variations to the features of its products without notice.